



Stappen plan Installatie Sensowash Starck F In combinatie met:

- Durasystem #WD1014
- Bedieningplaat A2 #WD5003012000
- Interface #100729 (communicatie reservoir Sensowash)
- Wateriaansluitset #100691
- Starck F Plus #650000 01 2 00 4320



Starck F inculsief Durasystem en A2 plaatmontage stappen plan:

1. Monteer eerst de interface op het reservoir.
2. Monteer reservoir. Let op electra voeding
3. Sluit water aan op reservoir
4. Breng electra voor Sensowash aan 220 V. rechts onder.



WC-element, geurafzuiging, hygiënespoeling, WD1014000000



Interface-set #100729



Interface zorgt voor de communicatie van de bediening van de douche WC met het inbouwreservoir en bedieningplaat A2

1. Aansluiten interFace

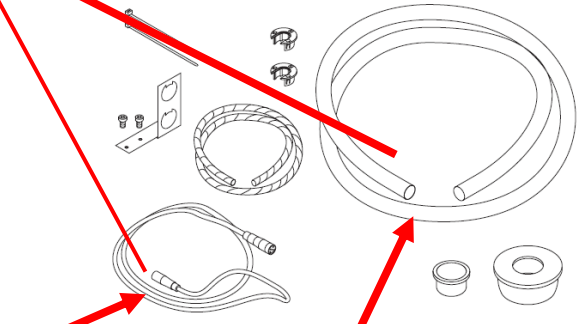
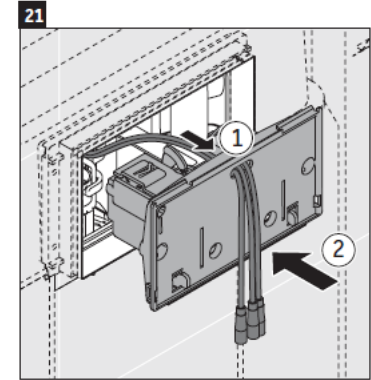
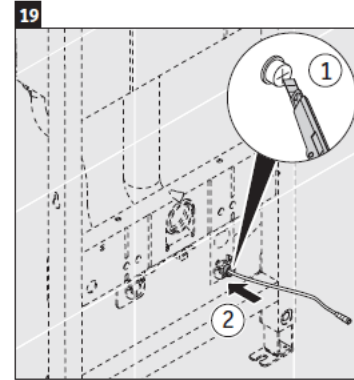
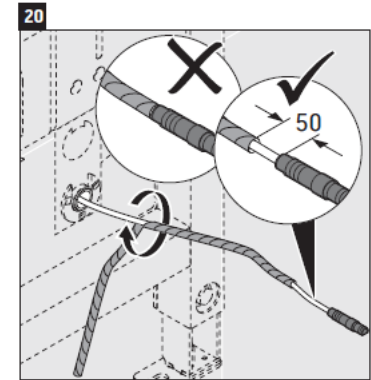
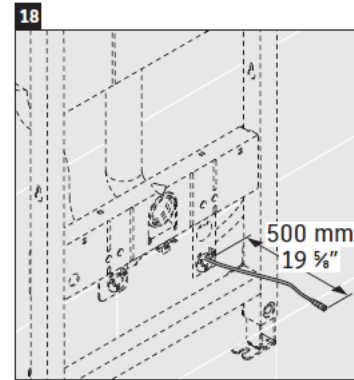
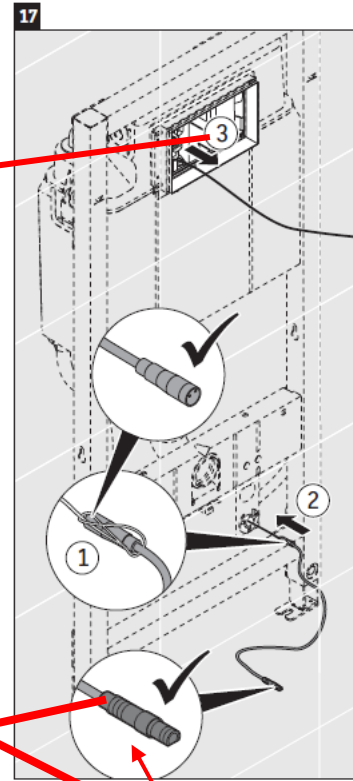
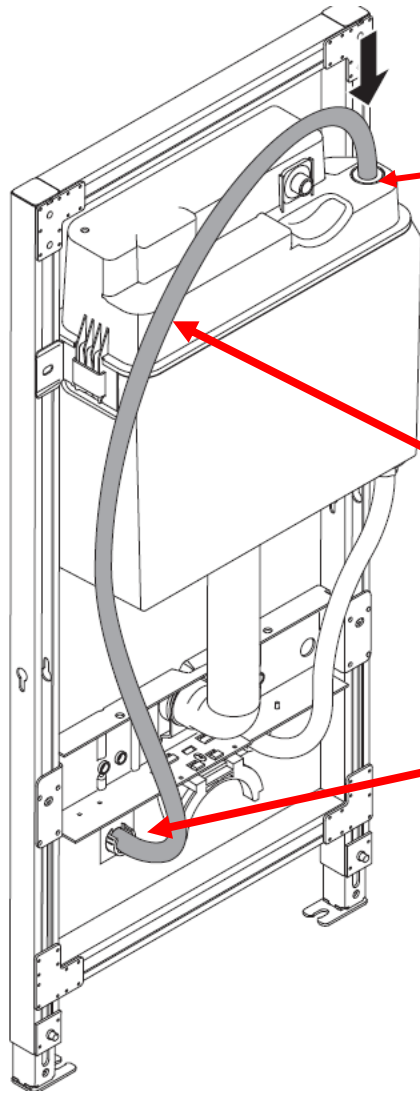

Interface Kabel

Loze leiding tbv kabel

Dit is een klein gedeelte van montage handleiding MAL57283 deze wel helemaal volgen.

2. Aansluiten reservoir

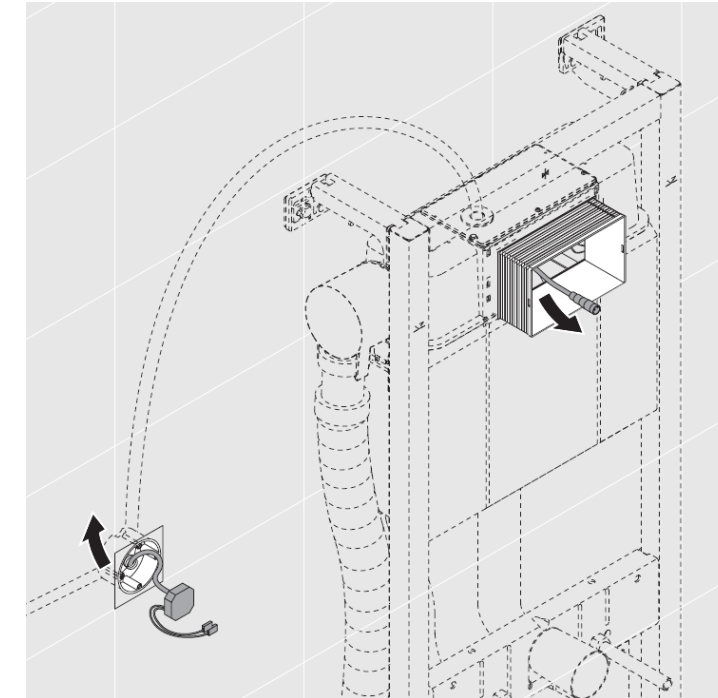
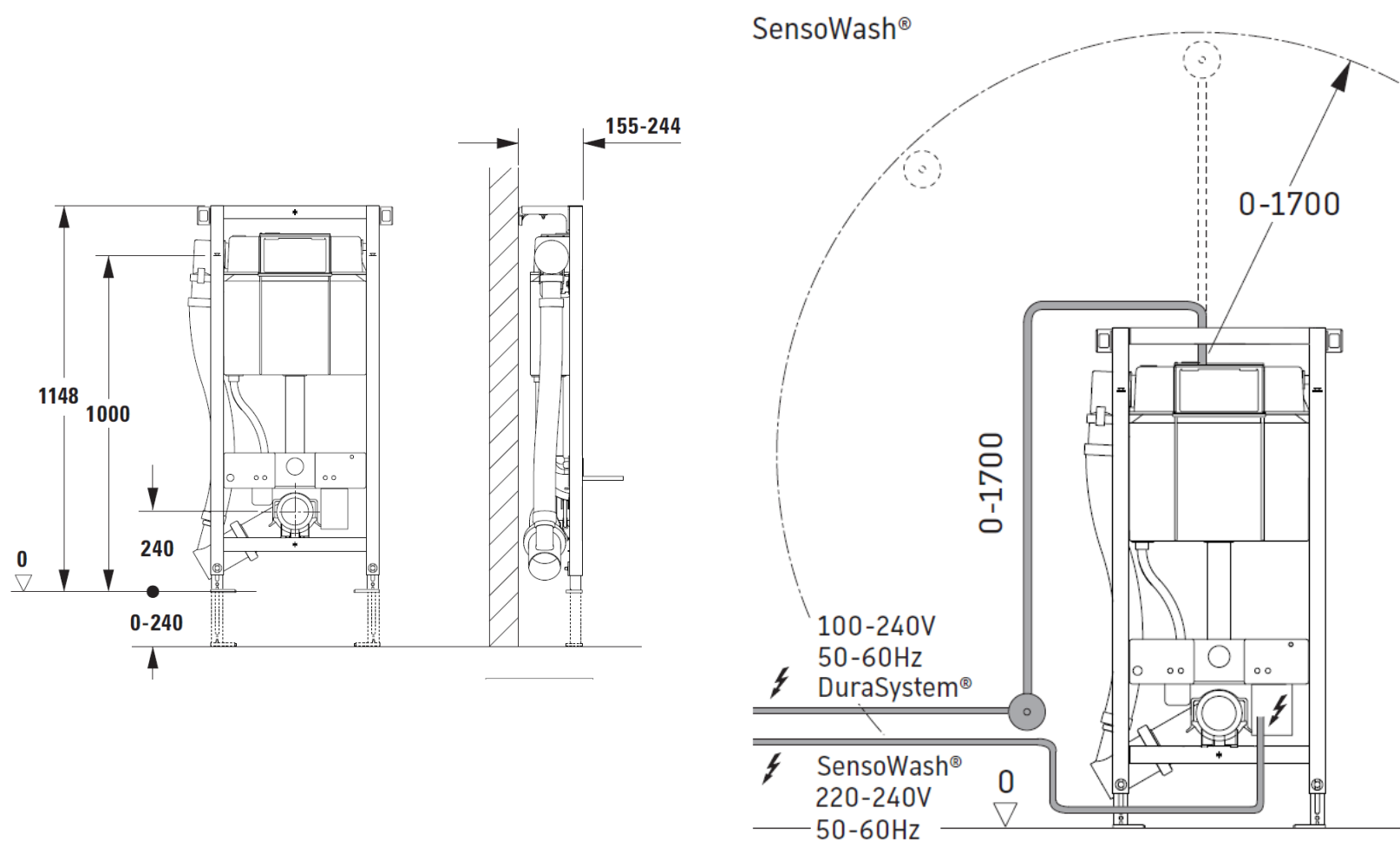

Aansluiten reservoir met extra aandacht voor de externe electra aansluiting !!
Verder alle stappen van de montage handleiding 70300111 volgen !!!

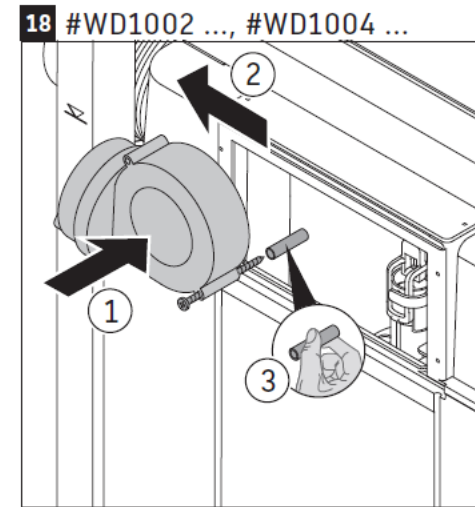
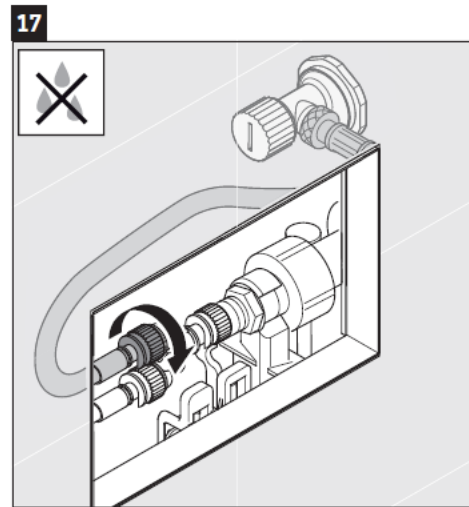
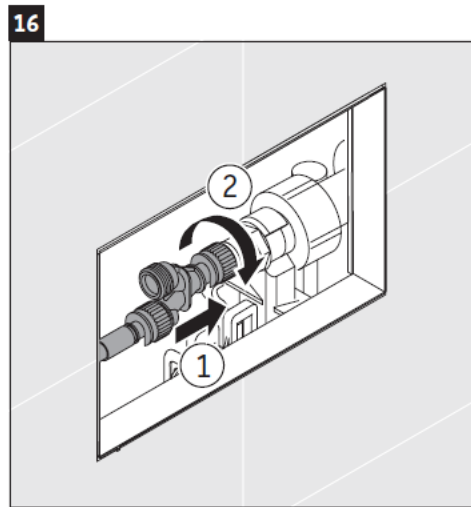
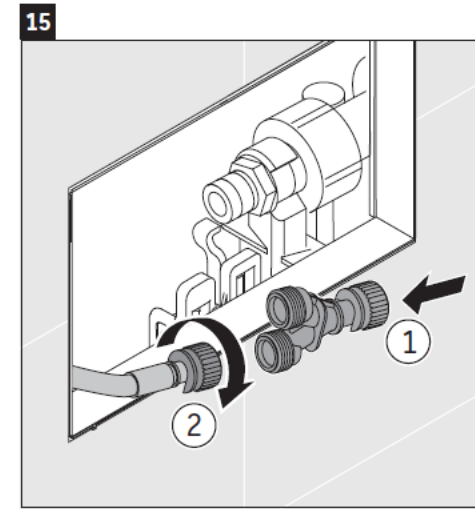
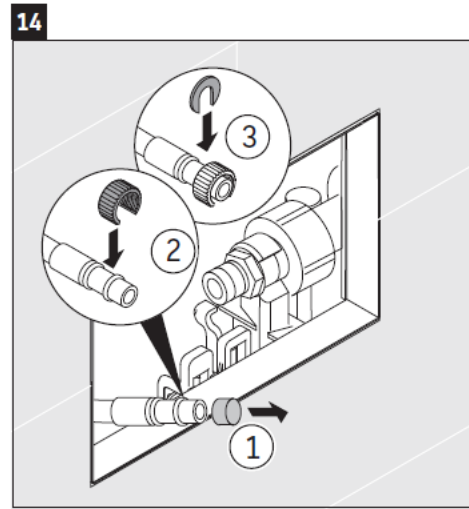
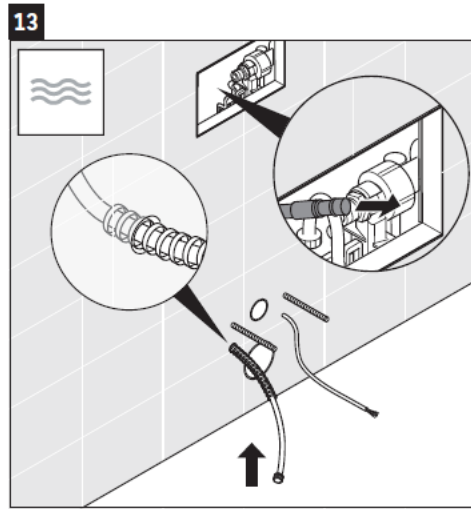

Aansluitset #100691



Aansluitset #100691 door de loze leiding links onder voeren en in de tank aansluiten.

Let op ook alle stappen volgen volgens Starck F montage handleidingen 100731

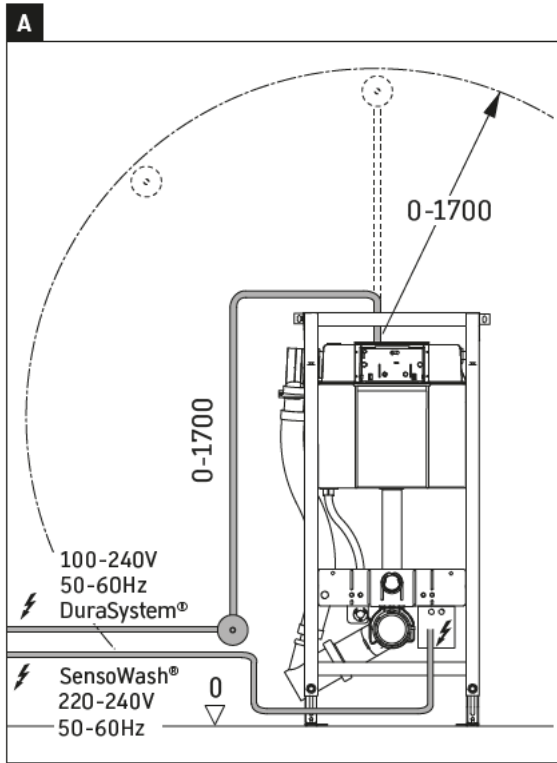

Lengte electra kabel
±800 mm.

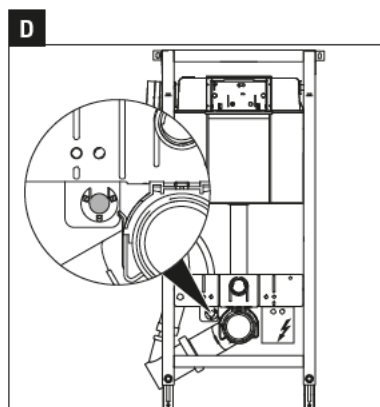
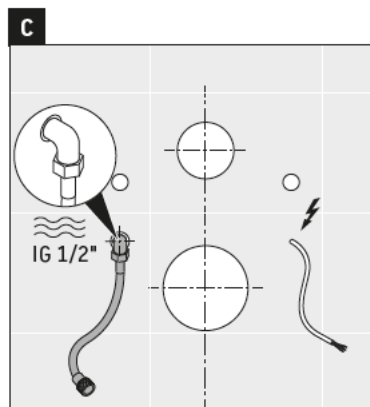
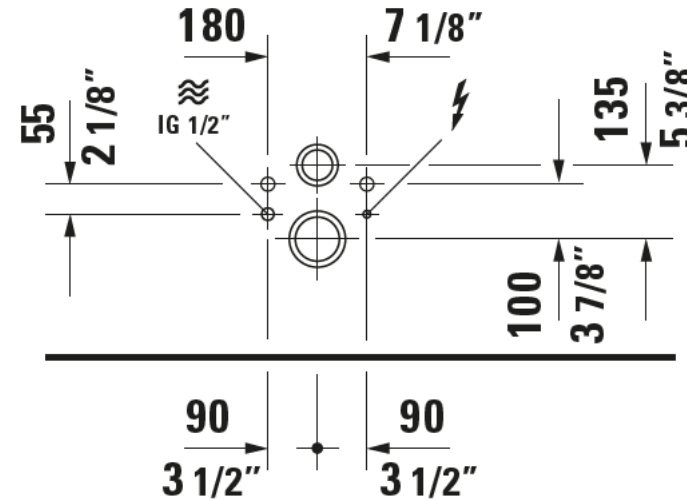
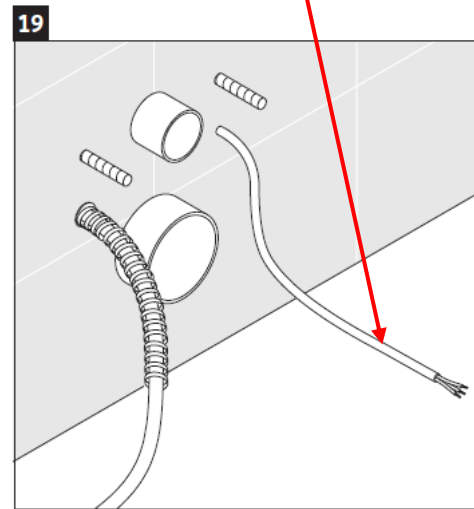

Tip !
Spanning op doucheWC als laatste
activeren

Uiteindelijk bij volledige montage komen er 5 stekkers uit het reservoir.

Deze van links naar rechts aansluiten dan de afdekplaat in de houder drukken.

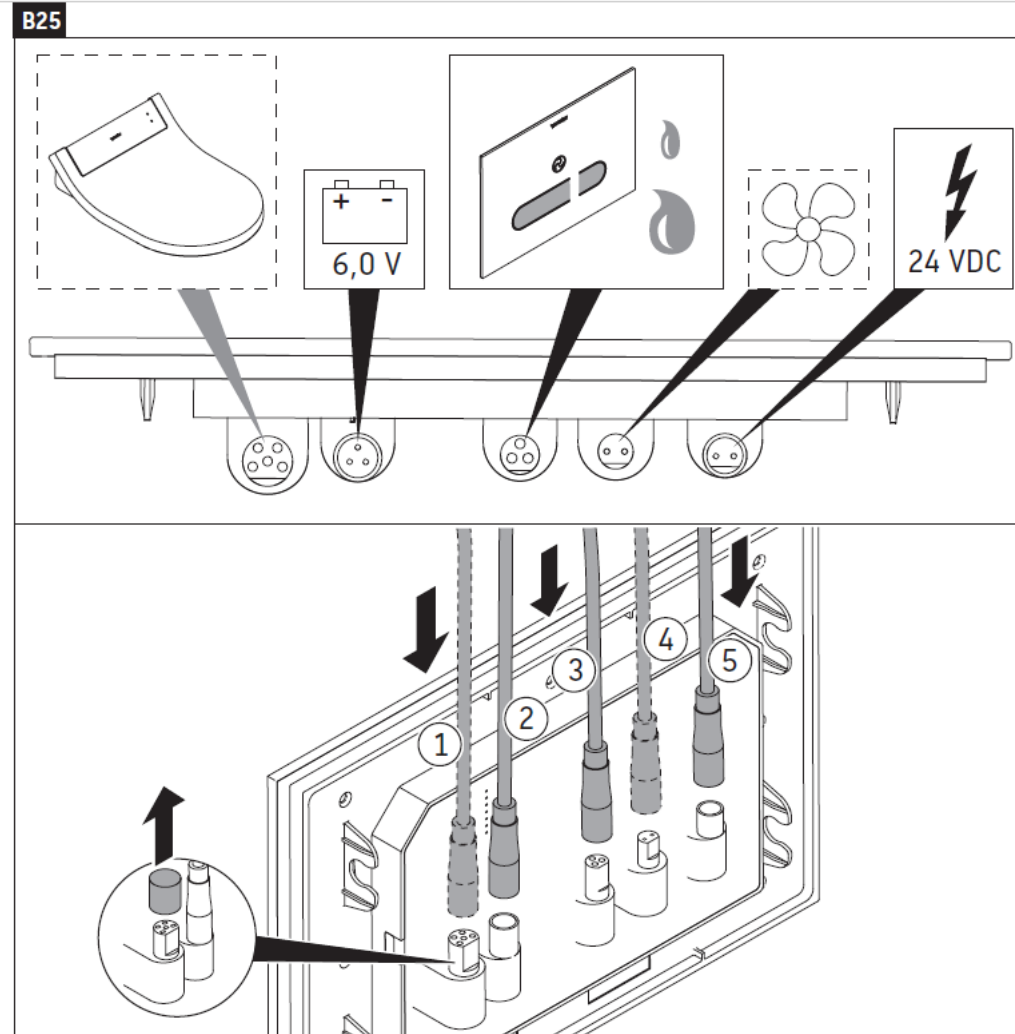
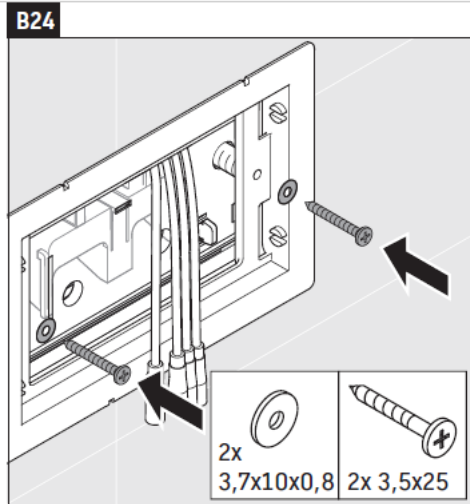

Bedieningsplaat A2, voor WC, Wit glas, WD5003012000

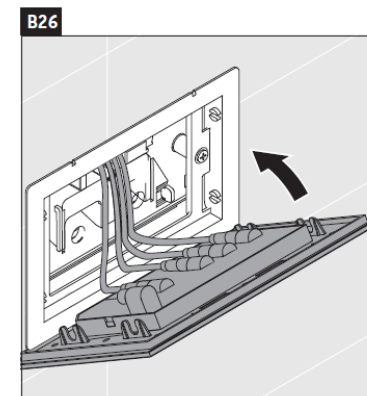

Dit is een stappenplan dat je wegwijs maakt
in de verschillende montage handleidingen.
Indien je een Starck F Plus of Lite gaat monteren inclusief
Durasystem inbouw reservoir en de A2 bedieningplaat.

Het is uiteraard wel zaak de handleidingen
in zijn geheel te volgen.

Wellicht ook handig de installatie video op YouTube te bekijken

[Duravit Durasystem installatievideo voor Duravit SensoWash Starck f douchewc - YouTube](#)