

# INSTALLATIE VOORSCHRIFT

DOUCHEDEUR IN NIS met NANO behandeld glas

1400x2000mm  
(1400-1420) x2000mm

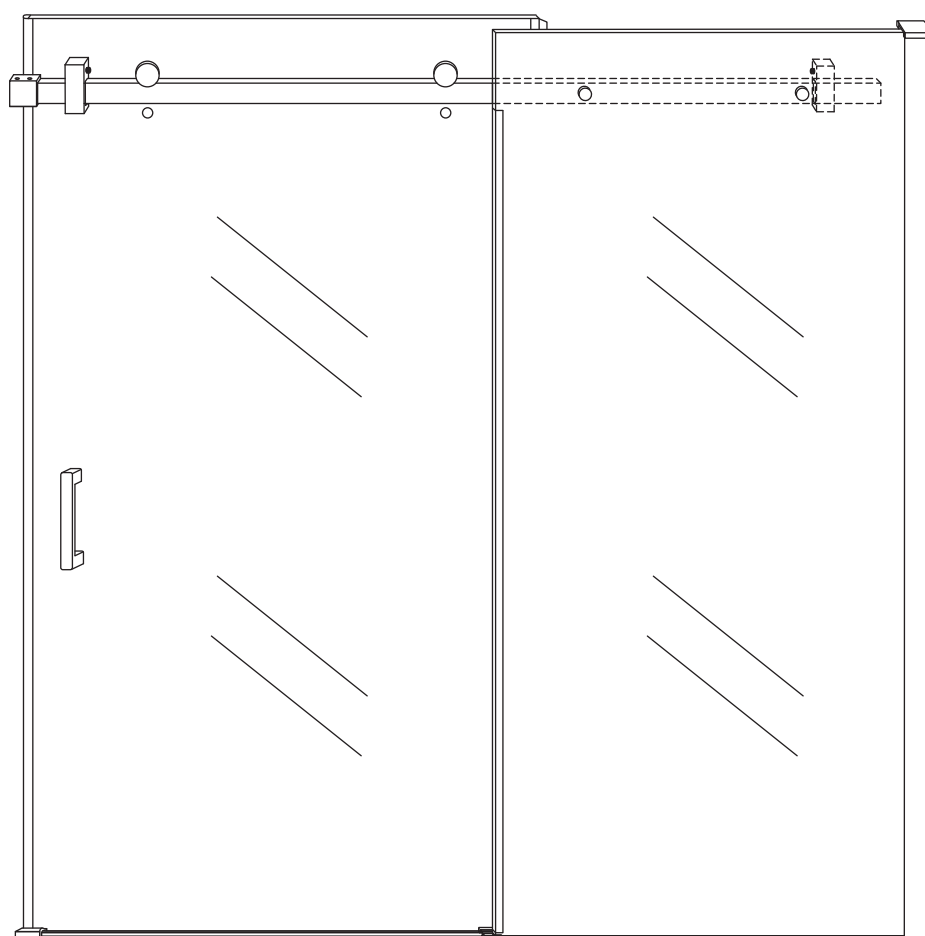



Zonder NANO

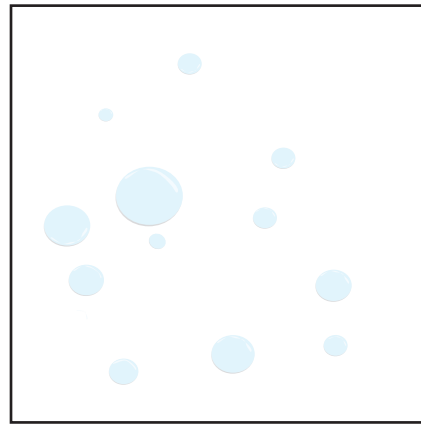

NANO



beide zijden NANO behandeld

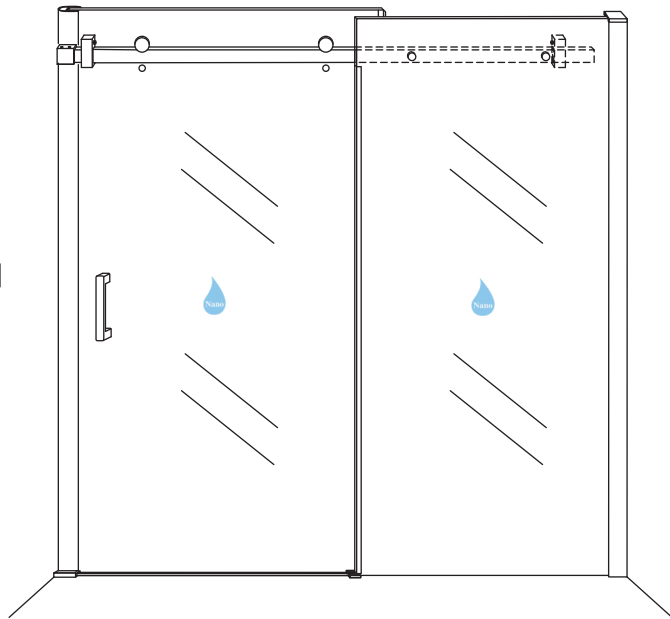

beide zijden NANO behandeld

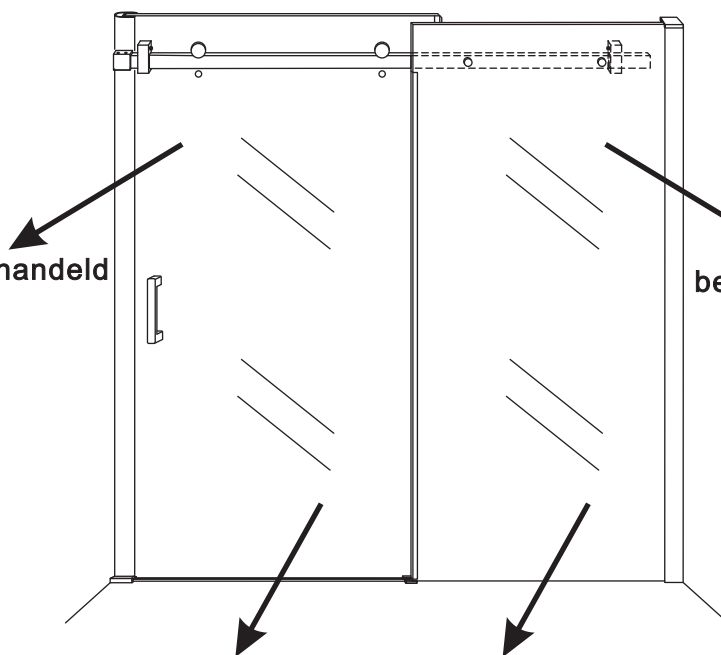

beide zijden NANO behandeld

**NANO garantie: 2 jaar bij normaal gebruik**

**LET OP: gebruik geen grove scherpe voorwerpen, zoals schuursponsjes of staalwol om het glas schoon te maken.**



1



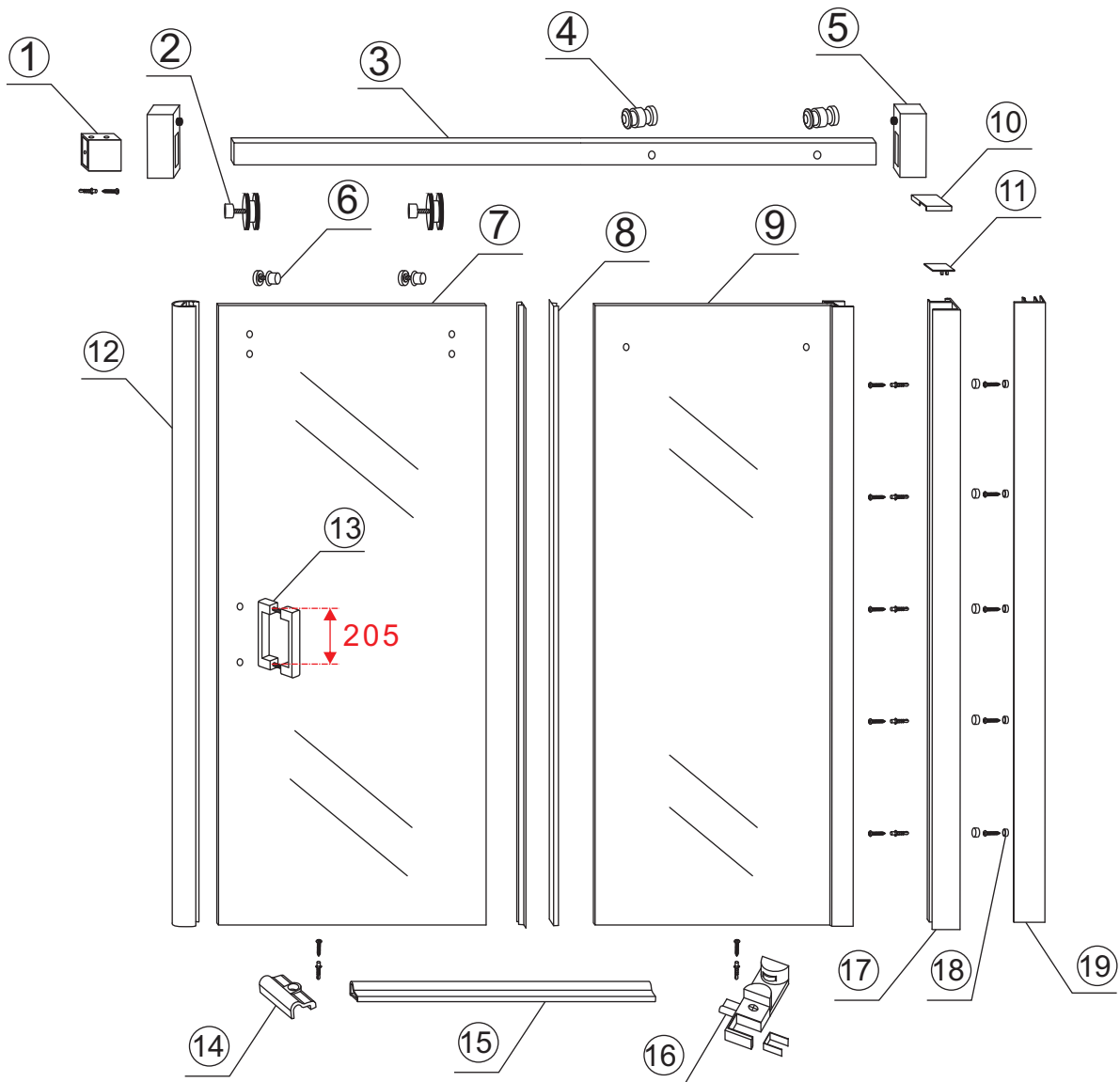

① X1	② X2	③ X1	④ X2	⑤ X2	⑥ X2	⑦ X1
⑧ X2	⑨ X1	⑩ X1	⑪ X1	⑫ X1	⑬ X1	⑭ X1
⑮ X1	⑯ X1	⑰ X1	⑱ X5	⑲ X1	X13	X8



# 3

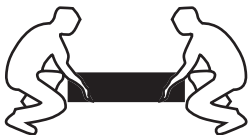
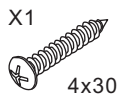
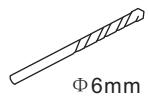
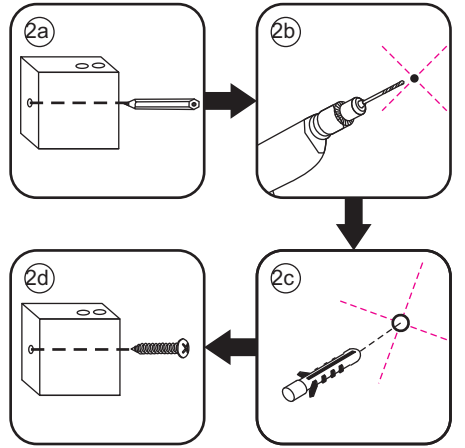
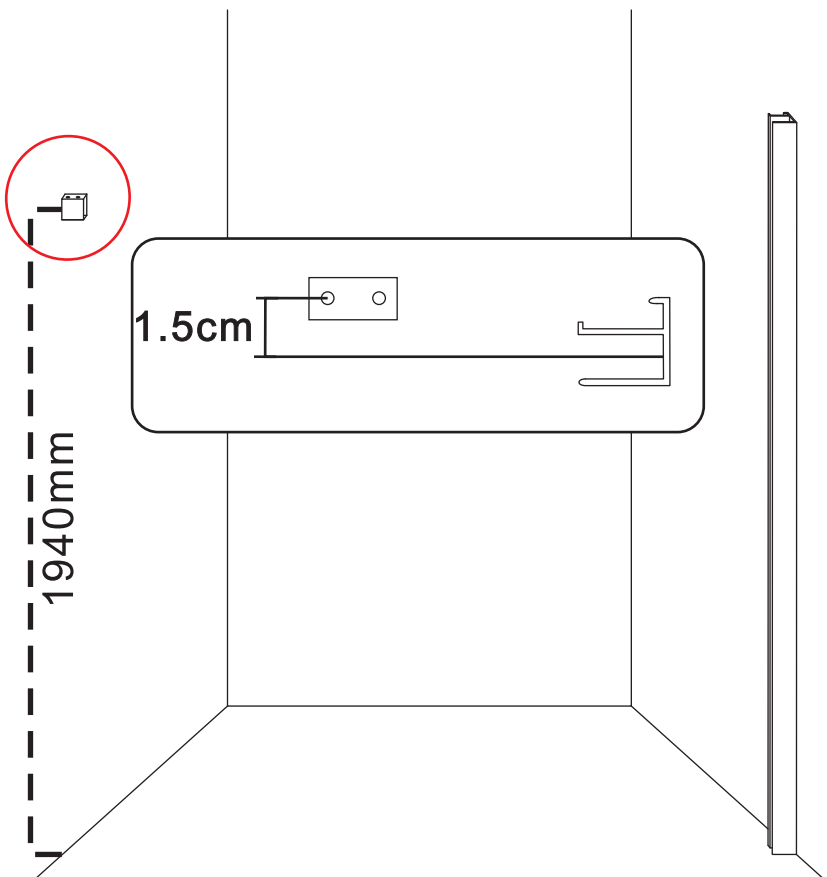
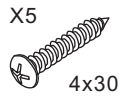
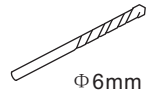
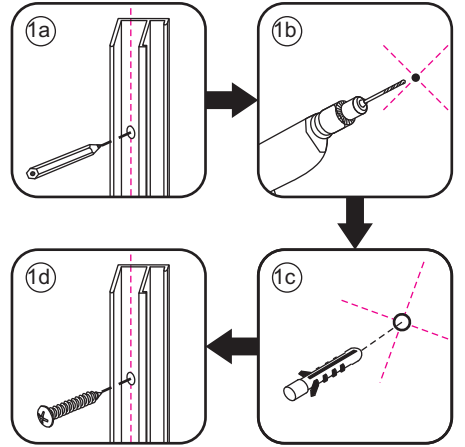
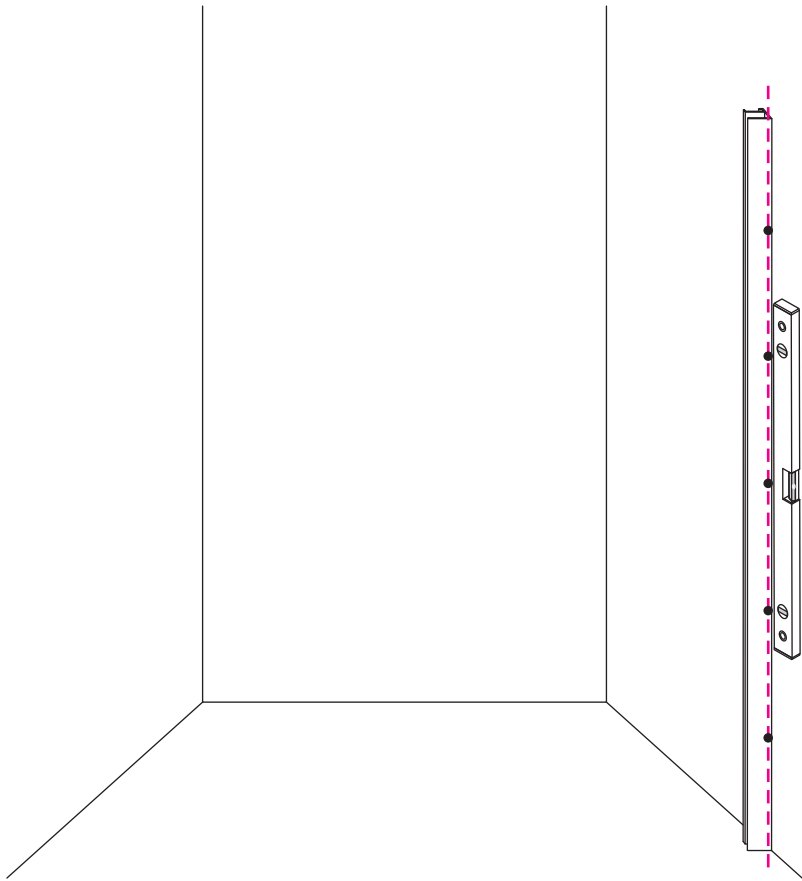

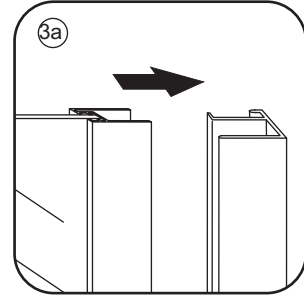
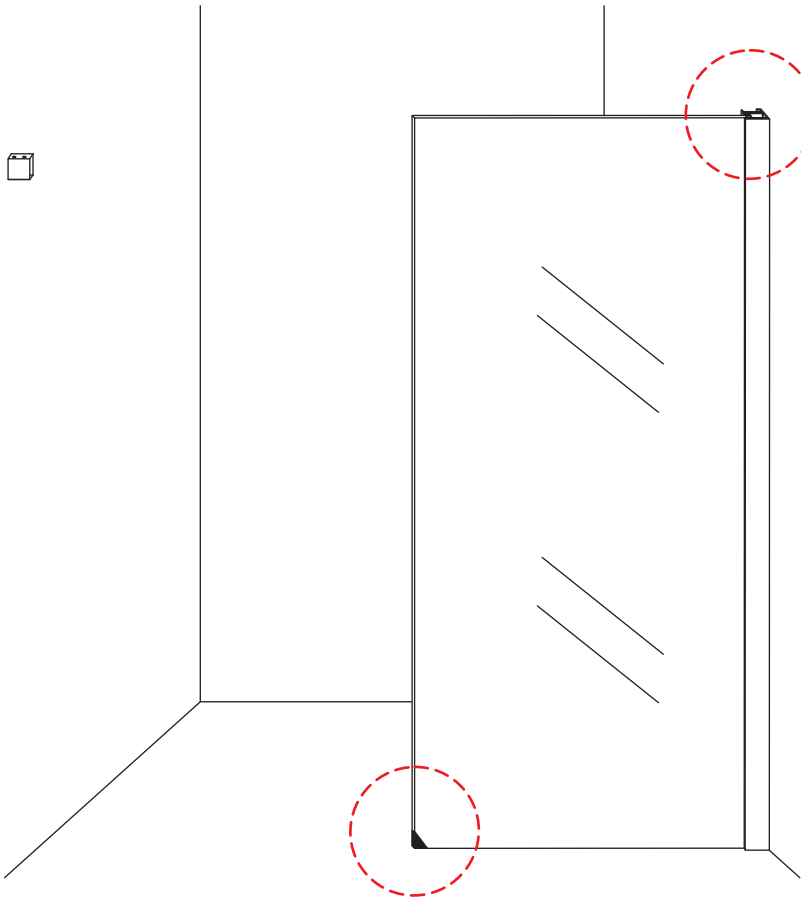

 **Verwijder de zwarte hoekbeschermers pas als de cabine helemaal is geïnstalleerd!**

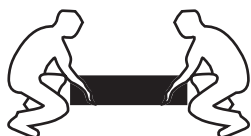
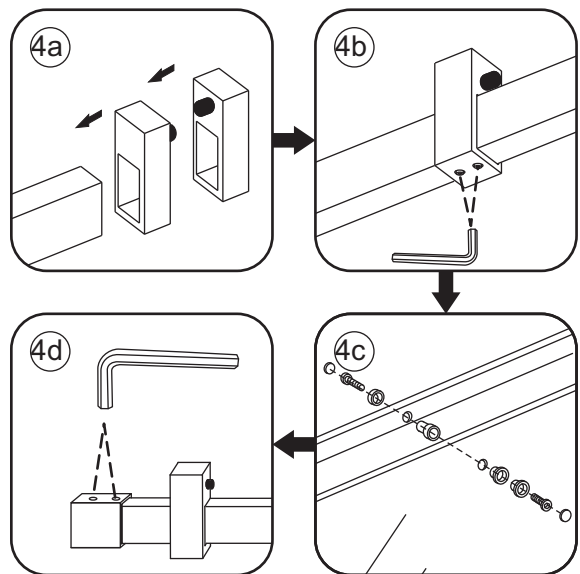
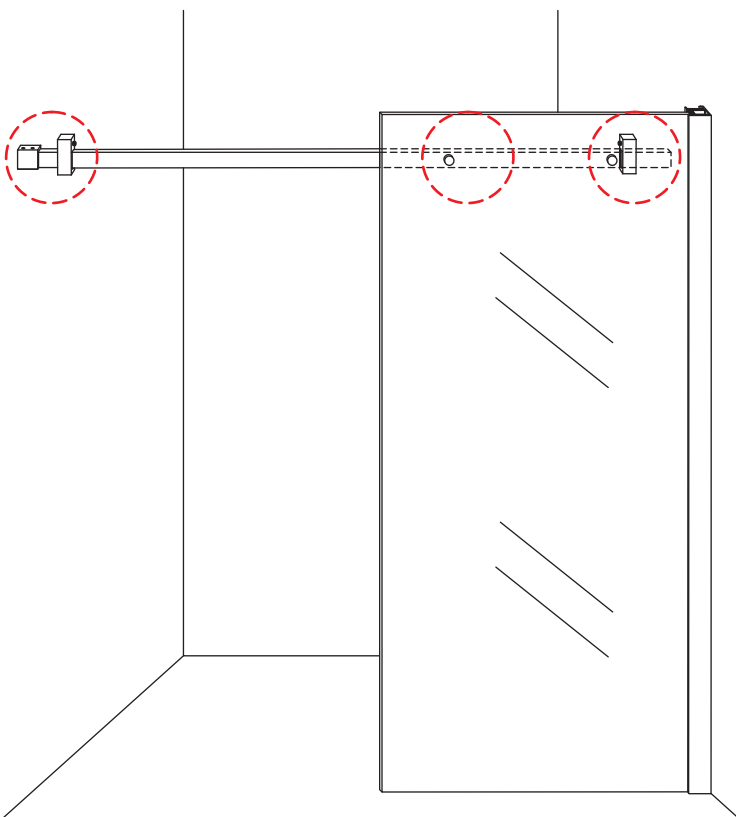

# 5

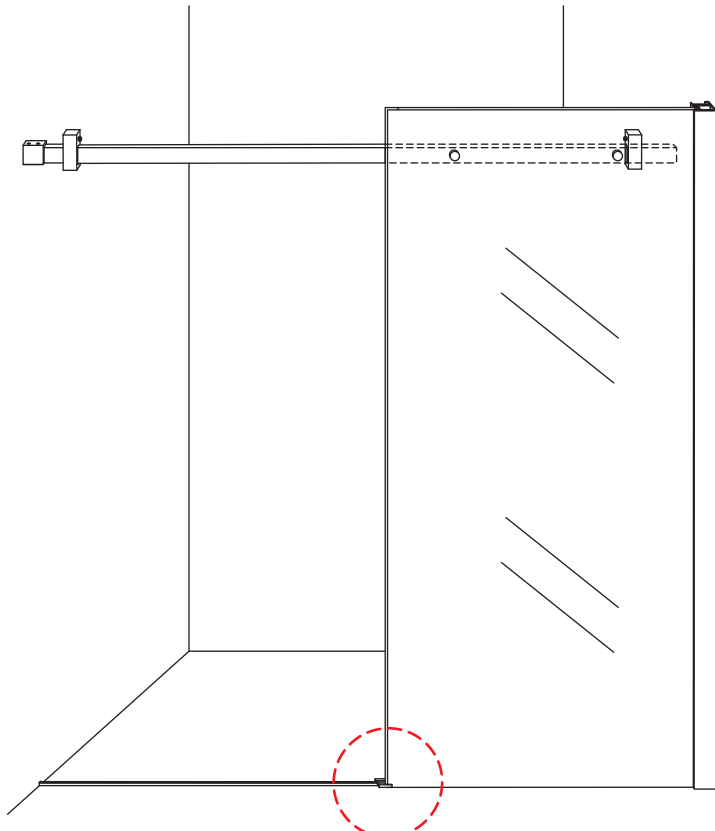

5a: Marking the door for the hinge attachment.

5b: Drilling a hole in the door.

5c: Drilling a hole in the cabinet frame.

5d: Inserting the hinge into the door hole.

5e: Inserting the hinge into the cabinet frame hole.

5f: Tightening the hinge with a screw.

Φ6mm X1    4x25 X1    Φ6x30 X1

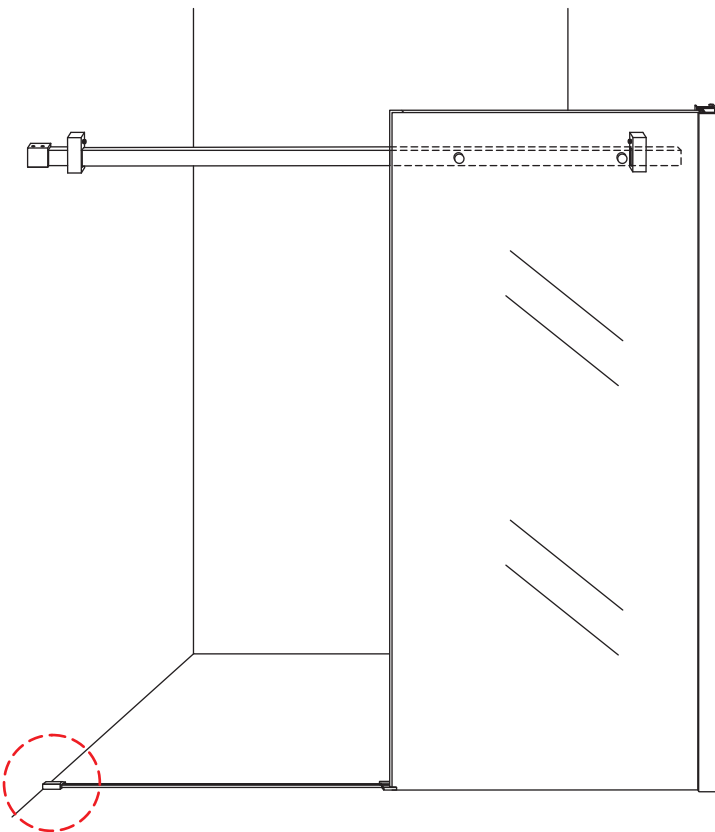

6a: Marking the door for the hinge attachment.

6b: Drilling a hole in the door.

6c: Drilling a hole in the cabinet frame.

6d: Inserting the hinge into the door hole.

6e: Inserting the hinge into the cabinet frame hole.

Φ6mm X1    4x25 X1    Φ6x30 X1

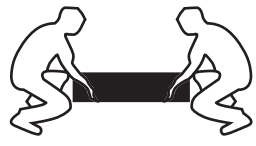

Φ6mm X1    4x25 X1    Φ6x30 X1

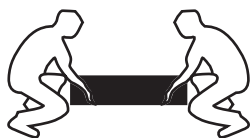
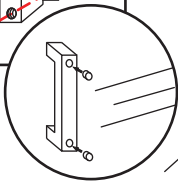
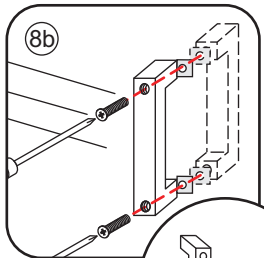
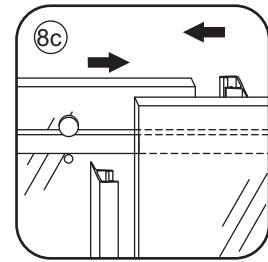
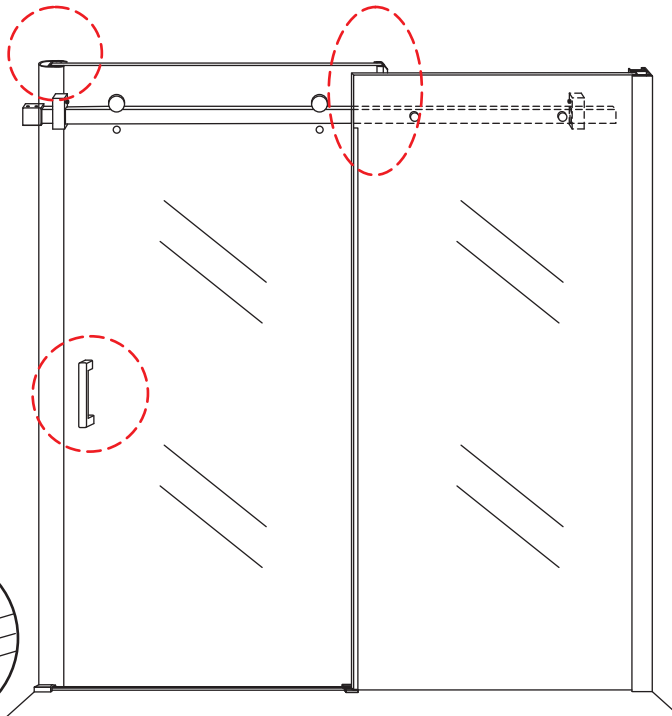
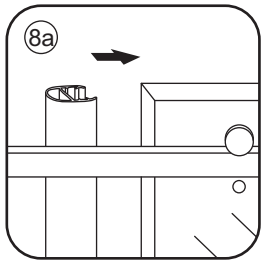
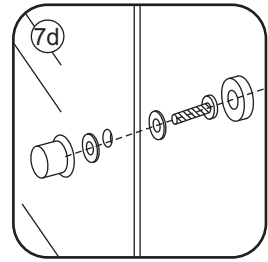
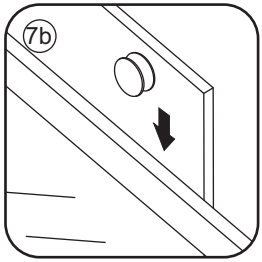
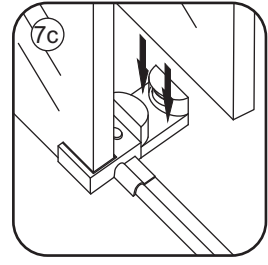
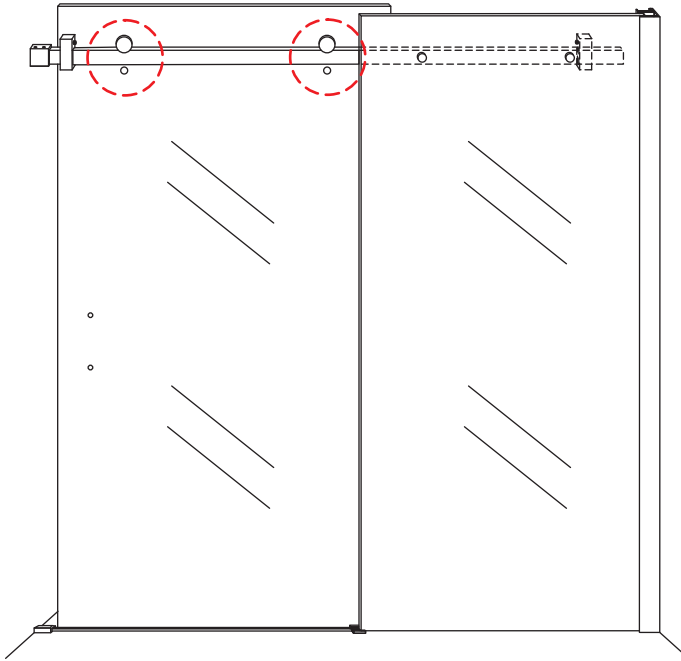
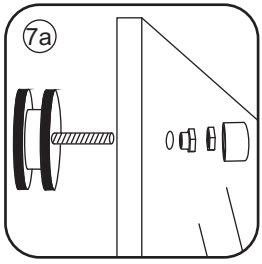



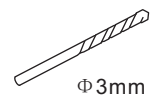
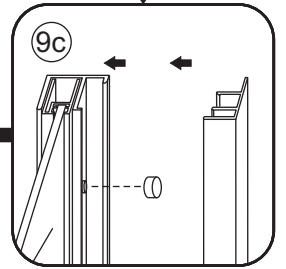
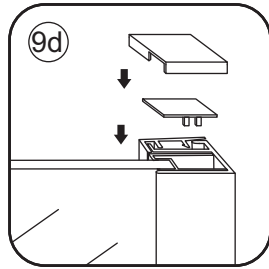
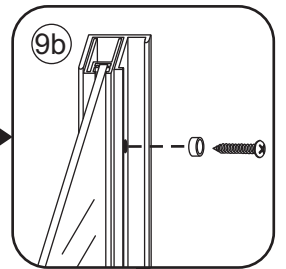
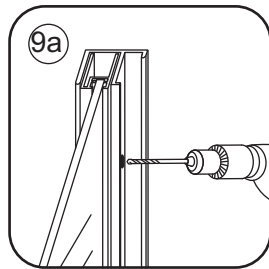
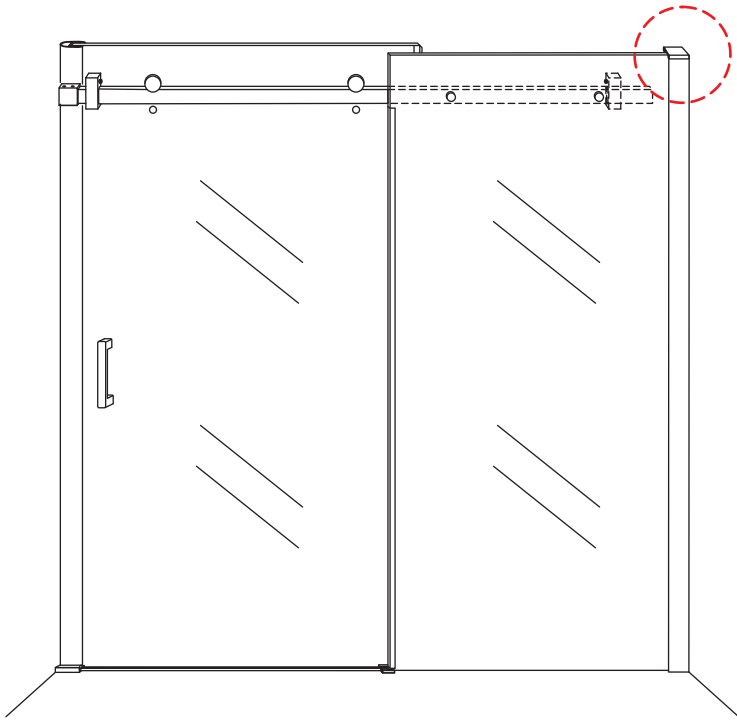

Φ 3mm

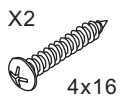

X2

4x16

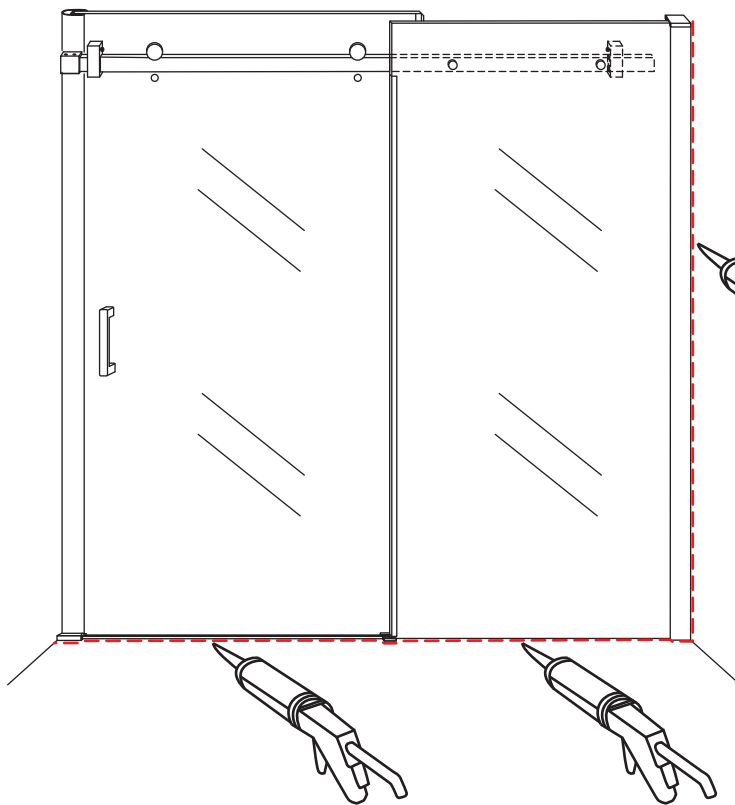

**Voorzie alleen de  
buitenzijde van de  
cabine van siliconenkit.**

