

DE	Gebrauchsanleitung / Montageanleitung	2
FR	Mode d'emploi / Instructions de montage	2
EN	Instructions for use / assembly instructions	3
IT	Istruzioni per l'uso / Istruzioni per l'installazione	3
ES	Modo de empleo / Instrucciones de montaje	4
NL	Gebruiksaanwijzing / Handleiding	4
DK	Brugsanvisning / Monteringsvejledning	5
PT	Instruções para uso / Manual de Instalação	5
PL	Instrukcja obsługi / Instrukcja montażu	6
CS	Návod k použití / Montážní návod	6
SK	Návod na použitie / Montážny návod	7
ZH	用户手册 / 组装说明	7
RU	Руководство пользователя / Инструкция по монтажу	8
HU	Használati útmutató / Szerelési útmutató	8
FI	Käyttöohje / Asennusohje	9
SV	Bruksanvisning / Monteringsanvisning	9
LT	Vartotojo instrukcija / Montavimo instrukcijos	10
HR	Upute za uporabu / Uputstva za instalaciju	10
TR	Kullanım kılavuzu / Montaj kılavuzu	11
RO	Manual de utilizare / Instrucțiuni de montare	11
EL	Οδηγίες χρήσης / Οδηγία συναρμολόγησης	12
SL	Navodilo za uporabo / Navodila za montažo	12
ET	Kasutusjuhend / Paigaldusjuhend	13
LV	Lietošanas pamācība / Montāžas instrukcija	13
SR	Uputstvo za upotrebu / Uputstvo za montažu	14
NO	Bruksanvisning / Montasjeveiledning	14
BG	Инструкция за употреба / Ръководство за монтаж	15
SQ	Udhëzuesi i përdorimit / Udhëzime rreth montimit	15
AR	دليل الاستخدام / تعليمات التجميع	16

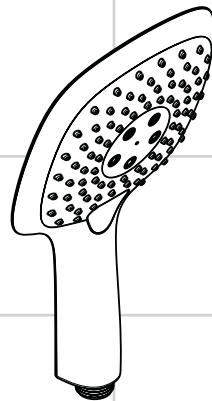

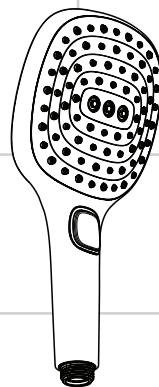



Raindance Select E 150
26550000 / 26550400



Raindance Select E 120
26520000 / 26520400



Sicherheitshinweise

-  Bei der Montage müssen zur Vermeidung von Quetsch- und Schnittverletzungen Handschuhe getragen werden.
-  Kinder, sowie Erwachsene mit körperlichen, geistigen und / oder sensorischen Einschränkungen dürfen das Duschsystem nicht unbeaufsichtigt benutzen. Personen, die unter Alkohol- oder Drogeneinfluss stehen, dürfen das Duschsystem nicht benutzen.
-  Der Kontakt der Brausestrahlen mit empfindlichen Körperstellen (z. B. Augen) muss vermieden werden. Es muss ein ausreichender Abstand zwischen Brause und Körper eingehalten werden.
-  Die Brause darf nur zur Bade-, Hygiene- und Körperreinigungszwecke eingesetzt werden.

Montagehinweise

Der beige packte Filtereinsatz muss eingebaut werden, um Schmutzeinspülungen aus dem Leitungsnetz zu vermeiden. Schmutzeinspülungen können die Funktion beeinträchtigen und/oder zu Beschädigungen an Funktionsteilen der Brause führen, für hieraus ergebende Schäden haftet Hansgrohe nicht.

Technische Daten

Betriebsdruck: max. 0,6 MPa
 Empfohlener Betriebsdruck: 0,1 - 0,4 MPa
 (1 MPa = 10 bar = 147 PSI)
 Heißwassertemperatur: max. 60°C
 Thermische Desinfektion: max. 70°C / 4 min
 Das Produkt ist ausschließlich für Trinkwasser konzipiert!

Symbolerklärung



Maße (siehe Seite 18)



Durchflussdiagramm (siehe Seite 18)



Bedienung (siehe Seite 17)







Reinigung (siehe Seite 20) und beiliegende Broschüre



Prüfzeichen (siehe Seite 18)

Consignes de sécurité

-  Lors du montage, porter des gants de protection pour éviter toute blessure par écrasement ou coupure.
-  Il est interdit aux enfants ainsi qu'aux adultes ayant des insuffisances physiques, psychiques et/ou motoriques d'utiliser la douche sans surveillance. De même, il est interdit à des personnes sous influence d'alcool ou de drogues d'utiliser la douche.
-  Éviter le contact du jet de la douchette avec les parties sensibles du corps (telles par ex. que les yeux). Veiller à respecter un écart suffisant entre la douchette et le corps
-  La douchette ne doit servir qu'à se doucher, à se nettoyer et à pratiquer une hygiène corporelle.

Instructions pour le montage

L'élément-filtre, pièce jointe, doit être installé pour éviter l'infiltration d'impuretés venant du réseau. Ceux-ci pourraient influencer le fonctionnement de ce produit et même endommager des pièces mobiles. Des réclamations à la suite de l'usage de la pomme de douche sans joint-tamis de hansgrohe ne peuvent pas faire partie de notre garantie.

Informations techniques

Pression de service autorisée: max. 0,6 MPa
 Pression de service conseillée: 0,1 - 0,4 MPa
 (1 MPa = 10 bar = 147 PSI)
 Température d'eau chaude: max. 60°C
 Désinfection thermique: max. 70°C / 4 min
 Le produit est exclusivement conçu pour de l'eau potable!

Description du symbole



Dimensions (voir page 18)



Diagramme du débit (voir page 18)



Instructions de service (voir page 17)



Nettoyage (voir page 20) et brochure ci-jointe







Classification acoustique et débit (voir page 18)



Montage
voir page 17



Safety Notes

-  Gloves should be worn during installation to prevent crushing and cutting injuries.
-  Children as well as adults with physical, mental and/or sensoric impairments must not use this shower system without proper supervision. Persons under the influence of alcohol or drugs are prohibited from using this shower system.
-  Do not allow the streams of the shower touch sensitive body parts (such as your eyes). An adequate distance must be kept between the shower and you.
-  The shower may only be used for bathing, hygiene and body cleansing purposes.

Installation Instructions

The filter insert must be used to protect the shower against incoming dirt by pipework. Incoming dirt leads to defects or/and can damage parts of the shower; such caused faults voids all liability and guarantee claims.

Technical Data

Operating pressure:	max. 0,6 MPa
Recommended operating pressure: (1 MPa = 10 bar = 147 PSI)	0,1 - 0,4 MPa
Hot water temperature:	max. 60 °C
Thermal disinfection:	max. 70 °C / 4 min
The product is exclusively designed for drinking water!	

Symbol description



Dimensions (see page 18)



Flow diagram (see page 18)







Operation (see page 17)



Cleaning (see page 20) and enclosed brochure

Indicazioni sulla sicurezza

-  Durante il montaggio, per evitare ferite da schiacciamento e da taglio bisogna indossare guanti protettivi.
-  I bambini e gli adulti affetti da menomazioni fisiche, psichiche e/osensoriali devono utilizzare il sistema della doccia solo sotto la supervisione di una persona responsabile.
-  Bisogna evitare il contatto fra il getto della doccia e parti del corpo delicate (ad es. gli occhi). Fra il soffione ed il corpo va mantenuta una distanza sufficiente.
-  La doccia deve essere impiegata solo per il bagno e utilizzo igienico e pulizia del corpo.

Istruzioni per il montaggio

Il filtro supplementare deve essere utilizzato per proteggere la doccia dai depositi di calcare. Tali impurità possono infatti causare difetti e/o danneggiare parti della doccia; in questo caso la Hansgrohe non risponde dei danni.

Dati tecnici

Pressione d'uso:	max. 0,6 MPa
Pressione d'uso consigliata: (1 MPa = 10 bar = 147 PSI)	0,1 - 0,4 MPa
Temperatura dell'acqua calda:	max. 60 °C
Disinfezione termica:	max. 70 °C / 4 min
Il prodotto è concepito esclusivamente per acqua potabile!	

Descrizione simbolo



Ingombri (vedi pagg. 18)



Diagramma flusso (vedi pagg. 18)



Procedura (vedi pagg. 17)



Pulitura (vedi pagg. 20) e brochure allegata



Test certificate (see page 18)



Segno di verifica (vedi pagg. 18)

Assembly
see page 17



Montaggio
vedi pagg. 17



⚠ Indicaciones de seguridad

- ⚠ Durante el montaje deben utilizarse guantes para evitar heridas por aplastamiento o corte.
- ⚠ Niños, así como adultos con limitaciones corporales, mentales y/o sensoriales no deben utilizar el sistema de duchas sin vigilancia. Personas que se encuentran bajo el efecto de alcohol o drogas, no deben utilizar el sistema de duchas.
- ⚠ Debe evitarse el contacto del chorro del pulverizador con partes sensibles del cuerpo (por ej. ojos). Debe mantenerse una distancia suficiente entre pulverizador y cuerpo.
- ⚠ La roseta de ducha solo debe utilizarse para fines de baño, higiene y limpieza corporal.

Indicaciones para el montaje

La inserción del filtro debe usarse para proteger la ducha de la suciedad proveniente de las tuberías. Debe colocarse entre el flexo y la ducha mural. Infiltraciones de suciedad deterioran el funcionamiento de la ducha mural y pueden causar daños en el interior de la misma que no están cubiertas por la garantía de Hansgrohe.

Datos técnicos

Presión en servicio: max. 0,6 MPa
 Presión recomendada en servicio: 0,1 - 0,4 MPa
 (1 MPa = 10 bar = 147 PSI)
 Temperatura del agua caliente: max. 60°C
 Desinfección térmica: max. 70°C / 4 min
 El producto ha sido concebido exclusivamente para agua potable.

⚠ Veiligheidsinstructies

- ⚠ Bij de montage moeten ter voorkoming van kniel- en snijwonden handschoenen worden gedragen.
- ⚠ Kinderen en volwassenen met lichamelijke, geestelijke en/of sensorische beperkingen mogen het douchesysteem niet zonder toezicht gebruiken. Personen onder invloed van alcohol of drugs mogen het douchesysteem niet gebruiken.
- ⚠ Het contact van de douchestraal met gevoelige lichaamsdelen (bijv. ogen) moet worden voorkomen. Er moet voldoende afstand tussen douche en lichaam aangehouden worden.
- ⚠ De douche uitsluitend toepassen in badkamers ten behoeve van lichaamsreiniging.

Montage-instructies

De bijgeleverde filter moet ingebouwd worden om uit de leidingen tegen te houden. Vuil uit de leidingen kan de werking van de hoofddouche negatief beïnvloeden en/of de hoofddouche beschadigen. Voor deze schade is Hansgrohe niet verantwoordelijk.

Technische gegevens

Werkdruk: max. max. 0,6 MPa
 Aanbevolen werkdruk: 0,1 - 0,4 MPa
 (1 MPa = 10 bar = 147 PSI)
 Temperatuur warm water: max. 60°C
 Thermische desinfectie: max. 70°C / 4 min
 Het product is uitsluitend ontworpen voor drinkwater!

Descripción de símbolos



Dimensiones (ver página 18)



Diagrama de circulación (ver página 18)



Manejo (ver página 17)



Limpiar (ver página 20) y folleto anexo

Symboolbeschrijving



Maten (zie blz. 18)



Doorstroombiagram (zie blz. 18)



Bediening (zie blz. 17)



Reinigen (zie blz. 20) en bijgevoegde brochure



Marca de verificación (ver página 18)







Keurmerk (zie blz. 18)





Sikkerhedsanvisninger

-  Ved monteringen skal der bruges handsker for at undgå kvæstelser og snitsår.
-  Børn som også voksne med fysiske, mentale og / eller sensoriske begrænsninger må ikke bruge brusersystemet uden opsyn. Personer som er under indflydelse af alkohol eller narkotika må ikke bruge brusersystemet.
-  Bruserstrålens kontakt med sensitive områder (f.eks. øjne) skal undgås. Der skal være en tilstrækkelig afstand mellem bruseren og kroppen.
-  Bruseren må kun bruges til at bruse, til hygiejne og rengøring af kroppen.





Monteringsanvisninger

Den vedlagte filterindsats skal monteres for at forhindre at der kommer smuds i bruseren fra rørsystemet. Indskyllet snavs kan have indflydelse på bruserens funktion og/eller føre til beskadigelser på bruserens funktionsdele.

Tekniske data

Driftstryk:	max. 0,6 MPa
Anbefalet driftstryk:	0,1 - 0,4 MPa
(1 MPa = 10 bar = 147 PSI)	
Varmtvandstemperatur:	max. 60°C
Termisk desinfektion:	max. 70°C / 4 min
Produktet er udelukkende beregnet til drikkevand!	

Avisos de segurança

-  Durante a montagem devem ser utilizadas luvas de protecção, de modo a evitar ferimentos resultantes de entalamentos e de cortes.
-  Crianças e adultos com deficiências motoras, mentais e/ou sensoriais não podem utilizar o sistema de duche sem monitorização. Pessoas que estejam sob a influência de álcool ou drogas não podem utilizar o sistema de duche.
-  Deve-se evitar o contacto dos jactos de água com partes do corpo sensíveis (p. ex. olhos). É necessário manter uma distância suficiente entre o chuveiro e o corpo.
-  O chuveiro só pode ser utilizado para fins de higiene pessoal.





Avisos de montagem

O filtro de inserção deve ser utilizado para proteger o chuveiro de areias e resíduos provenientes da tubagem. Resíduos e areias podem danificar componentes, ou provocar mau funcionamento do chuveiro; as avarias assim provocadas anulam a nossa responsabilidade e anulam a nossa garantia.





Dados Técnicos

Pressão de funcionamento:	max. 0,6 MPa
Pressão de func. recomendada:	0,1 - 0,4 MPa
(1 MPa = 10 bar = 147 PSI)	
Temperatura da água quente:	max. 60°C
Desinfecção térmica:	max. 70°C / 4 min
Este produto foi única e exclusivamente concebido para água potável!	

Symbolbeskrivelse

-  **Målene** (se s. 18)
-  **Doorstroombiagram** (se s. 18)
-  **Brugsanvisning** (se s. 17)
-  **Rengøring** (se s. 20) og vedlagt brochure

Descrição do símbolo

-  **Medidas** (ver página 18)
-  **Fluxograma** (ver página 18)
-  **Funcionamento** (ver página 17)
-  **Limpeza** (ver página 20) e brochura em anexo



Godkendelse (se s. 18)

Montering
se s. 17



Marca de controlo (ver página 18)

Montagem
ver página 17



**! Wskazówki bezpieczeństwa**

- △ Aby uniknąć zranień, takich jak zgniecenia czy przecięcia, podczas montażu należy nosić rękawice.
- △ Zarówno dzieci, jak i dorośli z fizycznymi, psychicznymi i/lub sensorycznymi ograniczeniami nie mogą korzystać z prysznica bez opieki. Osoby znajdujące się pod wpływem alkoholu lub narkotyków nie mogą korzystać z prysznica.
- △ Należy unikać kontaktu strumienia wypywającego z głowicy z wrażliwymi częściami ciała (np. oczami). Należy zachowywać odpowiednią odległość pomiędzy głowicą a ciałem.
- △ Prysznic może być używany tylko do kąpieli, higieny i czyszczenia ciała.

Wskazówki montażowe

Dołożony do opakowania filtr musi zostać zamontowany, jej zabezpieczeniu przed zabrudzeniami z rur. Zanieczyszczenia mogą prowadzić do nieprawidłowego działania prysznica lub spowodować jego uszkodzenie, za tak powstałe uszkodzenia Hansgrohe nie przejmuje odpowiedzialności.

Dane techniczne

Ciśnienie robocze:	maks. 0,6 MPa
Zalecane ciśnienie robocze:	0,1 - 0,4 MPa
(1 MPa = 10 bary = 147 PSI)	
Temperatura wody gorącej:	maks. 60°C
Dezynfekcja termiczna:	maks. 70°C / 4 min
Produkt stworzono wyłącznie do wody pitnej!	

Opis symbolu**Wymiary** (patrz strona 18)**Schemat przepływu** (patrz strona 18)**Obsługa** (patrz strona 17)**Czyszczenie** (patrz strona 20) i dołączona broszura**! Bezpečnostní pokyny**

- △ Pro zabránění řezným zraněním a pohmožděním je nutné při montáži nosit rukavice.
- △ Děti a dospělí osoby s tělesným, duševním a / nebo smyslovým postižením nesmí sprchový systém používat bez dozoru. Osoby pod vlivem alkoholu nebo drog nesmí sprchový systém používat.
- △ Je nutné zabránit kontaktu vodních paprsků sprchy s měkkými částmi těla (např. očima). Je nutné dodržovat dostatečný odstup mezi sprchou a tělem.
- △ Sprcha smí být používána pouze za účelem koupání a tělesné hygieny.

Pokyny k montáži

Do přívodu musí být zabudováno se sprchou dodávané sítko, aby zachycovalo nečistoty vyplavené z vodovodní sítě. Vyplavené nečistoty mohou ovlivnit funkci sprchy a nebo mohou vést i k jejímu poškození. Na takto vzniklé škody se nevztahuje záruka firmy Hansgrohe.

Technické údaje

Provozní tlak:	max. 0,6 MPa
Doporučený provozní tlak:	0,1 - 0,4 MPa
(1 MPa = 10 bar = 147 PSI)	
Teplota horké vody:	max. 60°C
Tepelná desinfekce:	max. 70°C / 4 min
Výrobky Hansgrohe jsou vhodné pro přímý kontakt s pitnou vodou.	

Popis symbolů**Rozměry** (viz strana 18)**Diagram průtoku** (viz strana 18)**Ovládání** (viz strana 17)**Čištění** (viz strana 20) a přiložená brožura**Znak jakości** (patrz strona 18)**Zkušební značka** (viz strana 18)



! Bezpečnostné pokyny

- △ Pri montáži musíte nosiť rukavice, aby ste predišli pomliaždeninám a rezným poraneniam.
- △ Sprchovací systém nesmú bez dozoru používať deti, ako aj dospelé osoby s telesným, duševným a/alebo zmyslovým postihnutím. Sprchovací systém nesmú používať ani osoby, ktoré sú pod vplyvom alkoholu alebo drog.
- △ Vyhýbajte sa kontaktu vodného lúča sprchy s citlivými miestami tela (napr. oči). Dodržiavajte dostatočnú vzdialenosť medzi sprchou a telom.
- △ Sprcha sa smie používať len na účely kúpania a telesnej hygieny.

Pokyny pre montáž

Do prívodu musí byť zabudované so sprchou dodávané sítko, aby zachytilo nečistoty vyplavené z vodovodnej siete. Vyplavené nečistoty môžu ovplyvniť funkciu sprchy, alebo spôsobiť jej poškodenie. Na takto vzniknuté škody sa nevzťahuje záruka firmy Hansgrohe.

Technické údaje

Prevádzkový tlak:	max. 0,6 MPa
Doporučený prevádzkový tlak:	0,1 - 0,4 MPa
(1 MPa = 10 bar = 147 PSI)	
Teplota teplej vody:	max. 60°C
Termická dezinfekcia:	max. 70°C / 4 min

Výrobok je koncipovaný výhradne pre pitnú vodu!

! 安全技巧

- △ 装配时为避免挤压和切割受伤，必须戴上手套。
- △ 不得让儿童和肢体、精神和/或意识有障碍的成人在不受监管的情况下使用淋浴系统。受酒精或毒品影响的人员不得使用淋浴系统。
- △ 必须避免让身体敏感部位（如眼睛）接触到莲蓬头喷水。必须保持莲蓬头与人头之间有足够的距离。
- △ 该莲蓬头仅允许作淋浴、卫生保健和身体清洁目的使用。

安装提示





必须装上花洒所自带的滤柱密封垫，以过滤管道里的杂质污物。杂质污物会影响花洒的功能和/或损坏花洒的功能部件，由此而产生的产品损坏不属于汉斯格雅的保修范围。

技术参数





工作压力:	最大 0,6 MPa
推荐工作压力:	0,1 - 0,4 MPa
(1 MPa = 10 bar = 147 PSI)	
热水温度:	最大 60°C
热力消毒:	最大 70°C / 4 分钟

该产品专为饮用水设计！

Popis symbolov

-  **Rozmery** (viď strana 18)
-  **Diagram prietoku** (viď strana 18)
-  **Obsluha** (viď strana 17)
-  **Čistenie** (viď strana 20) a priložená brožúra

符号说明

-  **大小** (参见第 18 页)
-  **流量示意图** (参见第 18 页)
-  **操作** (参见第 17 页)
-  **清洗** (参见第 20 页) 并附有小手册



Osvedčenie o skúške (viď strana 18)



检验标记 (参见第 18 页)



Montáž
viď strana 17



安装
参见第 17 页



Указания по технике безопасности

-  Во время монтажа следует надеть перчатки во избежание прищемления и порезов.
-  Дети, а также взрослые с физическими, умственными и/или сенсорными недостатками должны пользоваться душевой системой только под присмотром. Запрещается пользоваться душевой системой в состоянии алкогольного или наркотического опьянения.
-  Не допускайте попадания струи воды из разбрызгивателя на чувствительные части тела (например, на глаза). Разбрызгиватель следует устанавливать на достаточном расстоянии от тела.
-  Источник разбрызгивания разрешается использовать только в гигиенических целях для принятия ванны и личной гигиены.

Указания по монтажу

Для предотвращения попадания частиц грязи из водопроводной сети необходимо установить фильтр, прилагаемый к ручному душу. Частицы грязи могут нарушить отдельные функции и/или привести к повреждению функциональных деталей ручного душа, Hansgrohe не несет ответственность за повреждения вследствие отсутствия фильтра.

Технические данные

Рабочее давление: не более. 0,6 МПа
 Рекомендуемое рабочее давление: 0,1 - 0,4 МПа
 (1 МПа = 10 bar = 147 PSI)
 Температура горячей воды: не более. 60°C
 Термическая дезинфекция: не более. 70°C / 4 мин
 Изделие предназначено исключительно для питьевой воды!

Описание символов



Размеры (см. стр. 18)



Схема потока (см. стр. 18)







Эксплуатация (см. стр. 17)



Очистка (см. стр. 20) и прилагаемая брошюра

Biztonsági utasítások

-  A szerelésnél a zúzódások és vágási sérülések elkerülése érdekében kesztyűt kell viselni.
-  Gyermekek, valamint testileg, szellemileg fogyatékos vagy érzékelésben korlátozott személyek nem használhatják felügyelet nélkül a zuhanyrendszert. Alkohol és kábítószer befolyása alatt álló személyek nem használhatják a zuhanyrendszert.
-  Kerülni kell a zuhanyugár érintkezését érzékeny testrészekkel (pl. szemek). Be kell tartani a megfelelő távolságot a zuhanyfej és a test között.
-  A zuhanyt csak fürdő-higiéniai- és tisztítási célra szabad használni.

Szerelési utasítások

A kézi zuhanyhoz csomagolt szűrőtömítést be kell szerelni a vízhálózatból származó szennyeződések kiküszöbölésére. A beáramló szennyeződések akadályozhatják és / vagy teljesen tönkre is tehetik a zuhany funkcióit. Az ezekből adódó károkért a Hansgrohe nem felel.

Műszaki adatok

Üzemi nyomás: max. 0,6 MPa
 Ajánlott üzemi nyomás: 0,1 - 0,4 MPa
 (1 MPa = 10 bar = 147 PSI)
 Forróvíz hőmérséklet: max. 60°C
 Termikus fertőtlenítés: max. 70°C / 4 perc
 A terméket kizárólag ivóvízhez tervezték!

Szimbólumok leírása



Méretet (lásd a 18. oldalon)



Átfolyási diagramm (lásd a 18. oldalon)



Használat (lásd a 17. oldalon)



Tisztítás (lásd a 20. oldalon) és mellékelt brosúrával



Знак технического контроля
(см. стр. 18)



Vizsgajel (lásd a 18. oldalon)





Монтаж
см. стр. 17



Szerelés
lásd a 17. oldalon



Turvallisuusohjeet

-  Asennuksessa on käytettävä käsineitä puristumien ja viiltojen aiheuttamien tapaturmien estämiseksi.
-  Lapset ja ruumiillisesti, henkisesti ja/tai aistillisesti rajoittuneet aikuiset eivät saa käyttää suihkujärjestelmää ilman valvontaa. Alkoholien tai huumeiden vaikutuksessa olevat henkilöt eivät saa käyttää suihkujärjestelmää.
-  Suihkuveden kontaktia herkkien ruumiinosien (esim. silmien) kanssa on vältettävä. Suihkun ja vartalon välissä on oltava riittävä väli.
-  Suihkua saa käyttää vain kylpy-, hygieniä ja kehonpuhdistustarkoituksiin.





Asennusohjeet

Käsisuihkun mukana toimitettu sihtiiviste on asennettava paikalleen, jotta lian huuhtoutuminen vesijohtoverkostosta käsisuihkun estyy. Huuhtoutuvat likahiukkaset voivat häiritä suihkun toimintaa tai vahingoittaa toimintaosia, Hansgrohe ei vastaa tästä aiheutuneista vahingoista.

Tekniset tiedot

Käyttöpaine:	maks. 0,6 MPa
Suosittelut käyttöpaine:	0,1 - 0,4 MPa
(1 MPa = 10 bar = 147 PSI)	
Kuuman veden lämpötila:	maks. 60 °C
Lämpödesinfektio:	maks. 70 °C / 4 min
Tuote on suunniteltu käytettäväksi ainoastaan juomaveden kanssa!	

Säkerhetsanvisningar

-  Handskar ska bäras under monteringsarbetet så att man kan undvika kläm- och skärskadorgen werden.
-  Barn samt vuxna med fysiska, psykiska eller sensoriska funktionshinder får inte använda duschsystemet ensam. Personer som är påverkade av alkohol- eller droger får inte använda duschsystemet.
-  Undvik att rikta duschstrålarna mot känsliga kroppsdelar (t. ex. ögonen. Det måste finnas ett tillräckligt stort avstånd mellan duschen och kroppen.
-  Duschen får bar användas till dusch-, bad- och personlig hygien.

Monteringsanvisningar

Silpackningen som följer med duschen måste monteras för att undvika att smuts från ledningsnätet tränger in. Smuts som spolat in kan påverka funktionerna och/eller leda till skador på funktionsdelar i duschen. Hansgrohe fränsäger sig allt ansvar för skador som kan härledas till detta.

Tekniska data

Driftstryck:	max. 0,6 MPa
Rek. driftstryck:	0,1 - 0,4 MPa
(1 MPa = 10 bar = 147 PSI)	
Varmvattentemperatur:	max. 60 °C
Termisk desinfektio:	max. 70 °C / 4 min
Produkten är enbart avsedd för dricksvatten!	

Merkin kuvaus



Mitat (katso sivu 18)



Virtausdiagrammi (katso sivu 18)



Käyttö (katso sivu 17)



Puhdistus (katso sivu 20) ja oheinen esite

Symbolförklaring



Måtten (se sidan 18)



Flödesschema (se sidan 18)



Hantering (se sidan 17)



Rengöring (se sidan 20) och medföljande broschyr



Koestusmerkki (katso sivu 18)



Testsigill (se sidan 18)

Asennus
katso sivu 17



Montering
se sidan 17

**! Saugumo technikos nurodymai**

- ⚠ Apsaugai nuo užspaudimo ir įsijovimo montavimo metu mūvėkite pirštines.
- ⚠ Dušo sistema uždrausta naudotis vaikams, taip pat suaugusiems su fizine, dvasine negale ir (arba) sensorikos sutrikimais. Dušo sistema taip pat uždrausta naudotis asmenims, apsvaigusiems nuo alkoholio arba narkotikų.
- ⚠ Būtina vengti dušo vandens srovės kontakto su jautriomis kūno vietomis (pvz., akimis). Todėl būtina laikytis tinkamo atstumo nuo dušo.
- ⚠ Dušo galva naudojama tik maudymosi, higieniniai ir kūno švarinimo tikslais.

Montavimo instrukcija

Tinklelis, kuris yra rankų dušas pakuotėje, privalo būti įstatytas, kad būtų apsaugota nuo išorės nešvarumų. Nešvarumai gali pakenkti rankų dušas funkcionalumui ir (arba) sugadinti rankų dušas funkcines dalis. Tokiu atveju „Hansgrohe“ atsakomybės neprisiima.

Techniniai duomenys

Darbinis slėgis: ne daugiau kaip 0,6 MPa
 Rekomenduojamas slėgis: 0,1 - 0,4 MPa
 (1 MPa = 10 barų = 147 PSI)
 Karšto vandens temperatūra: ne daugiau kaip 60°C
 Terminis dezinfekavimas: ne daugiau kaip 70°C / 4 min
 Produktas skirtas tik geriamajam vandeniui!

Simbolio aprašymas**Išmatavimai** (žr. psl. 18)**Pralaidumo diagrama** (žr. psl. 18)**Eksploatacija** (žr. psl. 17)**Valymas** (žr. psl. 20) ir pridama brošiūra**! Sigurnosne upute**

- ⚠ Prilikom montaže se radi sprječavanja prignječjenja i posjekotina moraju nositi rukavice.
- ⚠ Djeca, kao i tjelesno, mentalno i/ili senzorno hendikepirane odrasle osobe ne smiju se koristiti sustavom tuša bez nadzora. Osobe koje su pod utjecajem alkohola ili droga ne smiju se koristiti sustavom tuša.
- ⚠ Mora se izbjegavati kontakt mlaza iz tuša s osjetljivim dijelovima tijela (npr. očima). Tijelo korisnika mora biti dovoljno udaljeno od tuša.
- ⚠ Tuš se smije primjenjivati samo za kupanje, tuširanje i osobnu higijenu.

Upute za montažu

Filter potrebno je ugraditi kako bi se regulirao protok vode i smanjio dotok prljavštine. Za eventualna oštećenja uzrokovana prljavštinom proizvođač Hansgrohe nije odgovoran.

Technički podatci

Najveći dopušteni tlak: tlak 0,6 MPa
 Preporučeni tlak: 0,1 - 0,4 MPa
 (1 MPa = 10 bar = 147 PSI)
 Temperatura vruće vode: tlak 60°C
 Termička dezinfekcija: tlak 70°C / 4 min
 Proizvod je koncipiran isključivo za pitku vodu!

Opis simbola**Mjere** (pogledaj stranicu 18)**Dijagram protoka** (pogledaj stranicu 18)**Upotreba** (pogledaj stranicu 17)**Čišćenje** (pogledaj stranicu 20) i priložena brošura**Bandymo pažyma** (žr. psl. 18)**Oznaka testiranja** (pogledaj stranicu 18)**Montavimas**
žr. psl. 17**Sastavljanje**
pogledaj stranicu 17



! Güvenlik uyarıları

- ⚠ Montaj esnasında ezilme ve kesilme gibi yaralanmaları önlemek için eldiven kullanılmalıdır.
- ⚠ Bedensel, ruhsal ve/veya sensörük engelli çocuk ve yetişkinler gözetimsiz olarak duş sistemini kullanmamalıdır. Alkol veya uyuşturucu etkisinde olanlar duş sistemini kullanmamalıdır.
- ⚠ Püskürtme başlıklarının hassas organlara teması (örn. gözler) önlenmelidir. Püskürtücü ile beden arasında yeterli mesafe bırakılmalıdır.
- ⚠ Su püskürtücü yalnızca banyo, hijyen ve yıkanma amaçları için kullanılabilir.

Montaj açıklamaları

El duşu kafasına eklenmiş olan süzgeç contası, boru şebekesinden sızan kirlerin önüne geçmek için, yerine monte edilmelidir. İçeri sızan bu kirler duşun fonksiyonunu sekteleyebilir ve/veya duşun fonksiyon parçaları üzerinde hasarlara sebep olabilir, bu yüzden meydana gelen hasarlardan Hansgrohe sorumlu tutulamaz.

Teknik bilgiler

İşletme basıncı:	azami 0,6 MPa
Tavsiye edilen işletme basıncı:	0,1 - 0,4 MPa
(1 MPa = 10 bar = 147 PSI)	
Sıcak su sıcaklığı:	azami 60 °C
Termik dezenfeksiyon:	azami 70 °C / 4 dak
Ürün sadece şebeke suyu için tasarlanmıştır!	

! Instrucțiuni de siguranță

- ⚠ La montare utilizați mănuși pentru evitarea contuziunilor și tăierii mâinilor.
- ⚠ Copiii și adulții cu dizabilități corporale, mintale și senzoriale nu pot utiliza sistemul de duș nesupravegheați. De asemenea este interzisă utilizarea sistemului de duș de către persoane, care se află sub influența alcoolului sau a drogurilor.
- ⚠ Evitați contactul jetului de apă cu părțile de corp sensibile (de ex. ochii). Țineți dușul la o distanță corespunzătoare de corp.
- ⚠ Dușul poate fi utilizat doar în scopuri de spălare, igienizare și de întreținere a igienei corporale.





Instrucțiuni de montare

Montați garnitura de filtru livrată împreună cu capătul de duș de mână pentru evitarea pătrunderii impurităților din rețeaua de alimentare. Impuritățile pătrunse pot influența funcționarea aparatului și/sau provoca deteriorarea capătului de duș. Garanția nu acoperă aceste daune.





Date tehnice

Presiune de funcționare:	max. 0,6 MPa
Presiune de funcționare recomandată:	0,1 - 0,4 MPa
(1 MPa = 10 bar = 147 PSI)	
Temperatura apei calde:	max. 60 °C
Dezinfecție termică:	max. 70 °C / 4 min
Produsul este destinat exclusiv pentru apă potabilă.	

Simge açıklaması

-  **Ölçüleri** (Bakınız sayfa 18)
-  **Akış diyagramı** (Bakınız sayfa 18)
-  **Kullanımı** (Bakınız sayfa 17)
-  **Temizleme** (Bakınız sayfa 20) ve birlikte verilen broşür

Descrierea simbolurilor

-  **Dimensiuni** (vezi pag. 18)
-  **Diagrama de debit** (vezi pag. 18)
-  **Utilizare** (vezi pag. 17)
-  **Curățare** (vezi pag. 20) și broșura alăturată



Kontrol işareti (Bakınız sayfa 18)



Certificat de testare (vezi pag. 18)

Montajı
Bakınız sayfa 17



Montare
vezi pag. 17

**⚠ Υποδειξεις ασφαλείας**

- ⚠ Για να αποφύγετε τραυματισμούς κατά τη συναρμολόγηση πρέπει να φοράτε γάντια.
- ⚠ Παιδιά ή ενήλικες με μειωμένες σωματικές, διανοητικές και/ή αισθητήριες ανεπάρκειες δεν επιτρέπεται να χρησιμοποιούν το σύστημα ντους χωρίς επιτήρηση. Άτομα υπό την επήρεια οινόπνευματος ή ναρκωτικών δεν επιτρέπεται να χρησιμοποιούν σε καμία περίπτωση το
- ⚠ Η επαφή δέσμης νερού του ντους με ευαίσθητες περιοχές του σώματος (π.χ. μάτια) πρέπει να αποφεύγεται. Διατηρείτε επαρκή απόσταση ανάμεσα στο ντους και το σώμα.
- ⚠ Το ντους επιτρέπεται να χρησιμοποιείται μόνο για το μπάνιο, τον καθαρισμό και την υγιεινή του σώματος.

Οδηγίες συναρμολόγησης

Πρέπει να εγκατασταθεί το παρέμβυσμα φίλτρου που συνοδεύει τον καταιονιστήρα κατά τέτοιο τρόπο, ώστε να αποφεύγονται ρύποι που προέρχονται από το δίκτυο ύδρευσης. Οι ρύποι από το δίκτυο ύδρευσης μπορούν να επηρεάσουν αρνητικά και/ή να προξενήσουν ζημιά στα λειτουργικά τμήματα του καταιονιστήρα (ντους). Τέτοιου είδους ζημιές δεν καλύπτονται από την εγγύηση Hansgrohe.

Τεχνικά Χαρακτηριστικά

Λειτουργία πίεσης: έως 0,6 MPa
 Συνιστώμενη λειτουργία πίεσης: 0,1 - 0,4 MPa
 (1 MPa = 10 bar = 147 PSI)
 Θερμοκρασία ζεστού νερού: έως 60 °C
 Θερμική απολύμανση: έως 70 °C / 4 min
 Το προϊόν έχει σχεδιαστεί αποκλειστικά για πόσιμο νερό!

Περιγραφή συμβόλων**Διαστάσεις** (βλ. σελίδα 18)**Διάγραμμα ροής** (βλ. σελίδα 18)**Χειρισμός** (βλ. σελίδα 17)**Καθαρισμός** (βλ. σελίδα 20) και **συνημμένο φυλλάδιο****⚠ Varnostna opozorila**

- ⚠ Pri montaži je treba nositi rokavice, da se preprečijo poškodbe zaradi zmečkanja ali urezov.
- ⚠ Otroci kot tudi odrasle osebe z omejenimi telesnimi, duševnimi in/ali senzoričnimi sposobnostmi ne smejo ne nadzorovano uporabljati sistema za prhanje. Osebe, ki so pod vplivom alkohola ali drog, sistema za prhanje ne smejo uporabljati.
- ⚠ Éviter le contact du jet de la douche avec les parties sensibles du corps (telles par ex. que les yeux). Veiller à respecter un écart suffisant entre la douche et le corps
- ⚠ Prha se sme uporabljati le z namenom vzdrževanja higiene oziroma umivanja kopalnice in telesa.

Navodila za montažo

Filter, ki je priložen ročni prhi, je potrebno vgraditi, da prho zaščitimo pred umazanijo iz vodovodne napeljave. Umazanija lahko okvari ali poškoduje dele ročne prhe. Za tako nastalo škodo Hansgrohe ne odgovarja.





Tehnični podatki

Delovni tlak: maks. 0,6 MPa
 Priporočeni delovni tlak: 0,1 - 0,4 MPa
 (1 MPa = 10 bar = 147 PSI)
 Temperatura tople vode: maks. 60 °C
 Termična dezinfekcija: maks. 70 °C / 4 min
 Proizvod je zasnovan izključno za sanitarno vodo!

Opis simbola**Mere** (glejte stran 18)**Diagram pretoka** (glejte stran 18)**Upravljanje** (glejte stran 17)**Čiščenje** (glejte stran 20) in priložena brošura**Σήμα ελέγχου** (βλ. σελίδα 18)**Preskusni znak** (glejte stran 18)**Συναρμολόγηση**
βλ. σελίδα 17**Montaža**
Glejte stran 17.



Ohutusjuhised

-  Kandke paigaldamisel muljumis- ja löihevigastuste vältimiseks kindaid.
-  Lapsed, samuti kehaliste, vaimsete või tajupiirangutega täiskasvanud ei tohi dušisüsteemi järelevaetava kasutada. Alkoholi või narkootikumide mõju all olevad isikud ei tohi dušisüsteemi kasutada.
-  Duši veejoad ei tohi kokku puutuda tundlike kehaosadega (nt silmad). Jätke duši ja keha vahele piisav vahe.
-  Dušiši tohib kasutada ainult vanniskäimiseks, hügieeniks ja keha pesemiseks.

Paigaldamisjuhised

Kaitsmaks dušši torust tuleva mustuse eest, on vaja paigaldada dušiga kaasasolev mustusesõel. Sissetulev mustus võib funktsioneerimist kahjustada ja/või rikkuda dušši detaile. Sellest tulenevate kahjude eest Hansgrohe ei vastuta.

Tehnilised andmed

Töörõhk	maks. 0,6 MPa
Soovitatav töörõhk:	0,1 - 0,4 MPa
(1 MPa = 10 baari = 147 PSI)	
Kuuma vee temperatuur:	maks. 60°C
Termiline desinfitatsioon:	maks. 70°C / 4 min
Toode on ette nähtud eranditult joogivee jaoks!	

Sümbolite kirjeldus



Mõõtude (vt lk 18)



Läbivooludiagramm (vt lk 18)







Kasutamine (vt lk 17)



Puhastamine (vt lk 20) ja kaasasolev brošüür

Drošības norādes

-  Montāžas laikā, lai izvairītos no saspiedumiem un iegriezumiem, nepieciešams nēsāt cimdus.
-  Bērni, kā arī pieaugušie ar fiziskiem, garīgiem un / vai sensoriskiem ierobežojumiem nedrīkst lietot šo dušas sistēmu bez uzraudzības. Personas, kas atrodas alkohola vai narkotisko vielu iespaidā, nedrīkst lietot šo dušas sistēmu.
-  Nepieciešams izvairīties no dušas strūkļas tieša kontakta ar jutīgām ķermeņa daļām (piem., acīm). Nepieciešams ievērot pietiekošu attālumu starp dušu un ķermeni.
-  Dušu drīkst izmantot vienīgi vannošānās, higiēnas un ķermeņa tīrīšanas nolūkiem.

Norādījumi montāžai

Jāņemotē dušas komplektā esošais filtrs, lai novērstu neīrimumu ieplūšanu no ūdens vada. Ieskalotie neīrimumi var traucēt dušas funkciju un / vai arī izraisīt rokas dušas daļu bojājumus, par kuriem Hansgrohe nenes atbildību.

Tehniskie dati

Darba spiediens:	maks. 0,6 MPa
Ieteicamais darba spiediens:	0,1 - 0,4 MPa
(1 MPa = 10 bar = 147 PSI)	
Karstā ūdens temperatūra:	maks. 60°C
Termiskā dezinfekcija :	maks. 70°C / 4 min
Izstrādājums ir paredzēts tikai dzeramajam ūdenim!	

Simbolu nozīme



Izmērus (skat. 18. lpp.)



Caurplūdes diagramma (skat. 18. lpp.)



Lietošana (skat. 17. lpp.)



Tīrīšana (skat. 20. lpp.) un klāt pievienotais buklets



Kontrollsertifikaat (vt lk 18)



Pārbaudes zīme (skat. 18. lpp.)





Paigaldamine
vt lk 17



Montāža
skat. 17. lpp.



Sigurnosne napomene

-  Prilikom montaže se radi sprečavanja prignječenja i posekotina moraju nositi rukavice.
-  Deca, kao i telesno, mentalno i/ili senzorno hendikepirane odrasle osobe ne smeju da koriste sistem tuša bez nadzora. Osobe koje su pod uticajem alkohola ili droga ne smeju da koriste sistem tuša.
-  Mora se izbegavati kontakt mlaza iz tuša sa osetljivim delovima tela (npr. očima). Telo korisnika mora biti na dovoljnom odstojanju od tuša.
-  Tuš sme da se koristi samo za kupanje, tuširanje i ličnu higijenu.





Instrukcije za montažu

Obavezno ugradite mrežicu (A) upakovanu s tušem, čime sprečavate ulazak prljavštine iz vodovoda. Prljavština može dovesti do delimičnog ili potpunog oštećenja delova tuša. Za eventualna oštećenja uzrokovana prljavštinom proizvođač Hansgrohe nije odgovoran.

Tehnički podaci

Radni pritisak:	maks. 0,6 MPa
Preporučeni radni pritisak:	0,1 - 0,4 MPa
(1 MPa = 10 bar = 147 PSI)	
Temperatura vruće vode:	maks. 60°C
Termička dezinfekcija:	maks. 70°C / 4 min
Proizvod je koncipiran isključivo za pijaću vodu!	

Sikkerhetshenvisninger

-  Bruk hansker under montasjonen for å unngå klem- og kuttskader.
-  Barn og voksne med fysiske og psykiske og/eller sensoriske handicap skal ikke bruke dusjsystemet uten oppsyn. Personer som er påvirket av alkohol eller narkotika skal ikke bruke dusjsystemet.
-  Dusjstrålen skal ikke komme i kontakt med ømfintlige kroppsdeler (f.eks. øynene). Overhold en tilstrekkelig avstand mellom dusjen og kroppen.
-  Dusjen skal kun brukes for bading, til hygieneformål og til kropprensing.

Montagehenvisninger

Medlevert filterinnsats skal bygges inn for å unngå smussinnspylinger fra ledningsnett. Smussinnspylinger kan påvirke funksjonen negativt og/eller medføre skader på dusjens funksjonsdeler. For skader som resulteres av dette påtar seg Hansgrohe inget ansvar.

Tekniske data

Driftstrykk	maks. 0,6 MPa
Anbefalt driftstrykk:	0,1 - 0,4 MPa
(1 MPa = 10 bar = 147 PSI)	
Varmtvannstemperatur	maks. 60°C
Termisk desinfisering:	maks. 70°C / 4 min
Produktet er utelukkende designet for drikkevann!	

Opis simbola



Mere (vidi stranu 18)



Dijagram protoka (vidi stranu 18)



Rukovanje (vidi stranu 17)



Čišćenje (vidi stranu 20) i priložena brošura

Symbolbeskrivelse



Mål (se side 18)



Gjennomstrømningsdiagram
(se side 18)



Betjening (se side 17)



Rengjøring (se side 20) og vedlagt brosjyre



Ispitni znak (vidi stranu 18)







Prøvemerket (se side 18)





Указания за безопасност

-  При монтажа трябва да се носят ръкавици, за да се избегнат наранявания поради притискане или порязване.
-  Не е позволено деца, както и възрастни с физически, умствени и / или сензорни ограничения да използват системата на душа без надзор. Не е позволено използването на системата на душа от лица, употребили алкохол или дрога.
-  Трябва да се избягва контакта на струите на разпръсквателя с чувствителни части на тялото (напр. очите). Между разпръсквателя и тялото трябва да се спазва достатъчно разстояние.
-  Позволено е използването на разпръсквателя само за къпане, хигиена и цели на почистване на тялото.

Указания за монтаж

Приложената в опаковката филтърна вложка трябва да се монтира, за да се избегне натрупване на замърсявания от водопроводната мрежа. Натрупването на замърсявания може да наруши функцията и/или да доведе до увреждания на функционалните части на разпръсквателя, Hansgrohe не носи отговорност за получените се по този начин щети.

Технически данни

Работно налягане: макс. 0,6 МПа
 Препоръчително работно налягане: 0,1 - 0,4 МПа (1 МПа = 10 bar = 147 PSI)
 Температура на горещата вода: макс. 60°C
 Термична дезинфекция: макс. 70°C / 4 мин
 Продуктът е разработен само за питейна вода!

Описание на символите



Размери (вижте стр. 18)



Диаграма на потока (вижте стр. 18)



Обслужване (вижте стр. 17)







Почистване (вижте стр. 20) и приложена брошура



Контролен знак (вижте стр. 18)

Udhëzime sigurie

-  Për të evituar lëndimet e pickimeve ose të prerjeve gjatë procesit të montimit duhet që të vishni doreza.
-  Fëmijët dhe të rriturit me aftësi të kufizuara fizike, mendore dhe/ose ndijuese nuk duhet ta përdorin sistemin e dushit pa qenë nën mbikëqyrje. Personat që janë nën ndikimin e drogave ose të alkoolit nuk duhet ta përdorin sistemin e dushit.
-  Kontakti i valëve të dushit me pjesët e ndjeshme të trupit (p.sh. me sytë) duhet që të shmanget. Midis dushit dhe trupit duhet që të mbahet një distancë e mjaftueshme.
-  Dushi duhet të përdoret vetëm për qëllimet e banjave, të higjienës dhe të larjes së trupit.

Udhëzime për montimin

Filtri i bashkëngjitur duhet montuar për të evituar thithjen e ndotjeve nga rrjeti i ujësjetillësit. Papastërtitë mund të dëmtojnë pjesë funksionale të dorezës. Hansgrohe nuk merr përgjegjësinë për dëmet e shkaktuara në këtë mënyrë.

Të dhëna teknike

Presioni gjatë punës maks. 0,6 МПа
 Presioni i rekomanduar: 0,1 - 0,4 МПа (1 МПа = 10 bar = 147 PSI)
 Temperatura e ujit të ngrohtë maks. 60°C
 Dezinfektim Termik: maks. 70°C / 4 min
 Produkti është projektuar ekskluzivisht për ujë të pijshëm!

Përshkrimi i simbolit



Përmasat (shih faqen 18)



Diagrami i qarkullimit (shih faqen 18)



Përdorimi (shih faqen 17)



Pastrimi (shih faqen 20) dhe broshura bashkëngjitur



Shenja e kontrollit (shih faqen 18)

Монтаж
вижте стр. 17



Montimi
shih faqen 17



تنبيهات الأمان



يجب إرتداء قفازات لليد أثناء التركيب لتجنب حدوث أخطار الإنتشار أو الجروح.



لا يسمح لأي أطفال أو أفراد بالغين يعانون من إعاقات بدنية أو ذهنية أو حسية أو يعانون من جميع هذه الإعاقات باستخدام المنتج إلا تحت إشراف آخرين. كما أنه لا يسمح لأي شخص تحت تأثير تناول الكحول أو المخدرات باستخدام نظام الدش.



يجب تجنب حدوث إتصال مباشر بين الماء الخارج من رأس الدش وبين أجزاء الجسم الحساسة (مثل العينين). يجب وجود مسافة كافية بين رأس الدش والجسم.



يسمح باستخدام الدش فقط لأغراض الإستحمام، والأغراض الصحية، وتنظيف الجسم.



تعليمات التركيب

يجب إدخال الحلقة الشبكية لحماية الدش اليدوي من الأوساخ التي تحملها شبكة المواسير. حيث تؤدي الأوساخ الواردة إلى حدوث أعطال أو / و قد تتسبب في تلف أجزاء من من الدش، ومثل هذه الأعطال تلغي كافة المطالبات الخاصة بالمسؤولية أو الضمان.

المواصفات الفنية

ضغط التشغيل: الحد الأقصى 0,6 ميجاباسكال
 ضغط التشغيل الموصى به: 0,4 - 0,1 ميجاباسكال
 (1 ميجاباسكال = 10 بار = 147 PSI)
 درجة حرارة الماء الساخن: الحد الأقصى 60°C
 تعقيم حراري: الحد الأقصى 70°C / 4 الدقيقة
 المنتج مخصص فقط لماء الشرب!

وصف الرمز

أبعاد (راجع صفحة 18)



رسم للصرف (راجع صفحة 18)



التشغيل (راجع صفحة 17)



التنظيف (راجع صفحة 20) والكتيب المرفق



شهادة اختبار (راجع صفحة 18)



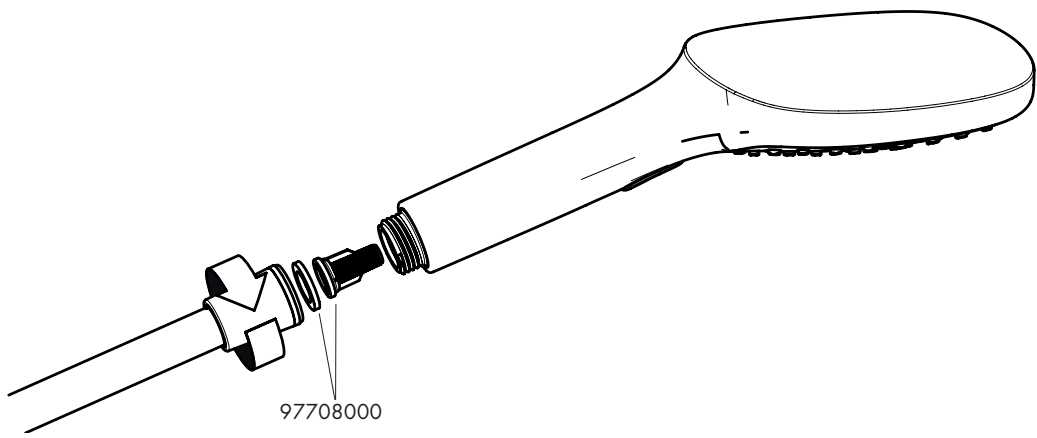

97708000





Raindance Select E 120
26520000 / 26520400

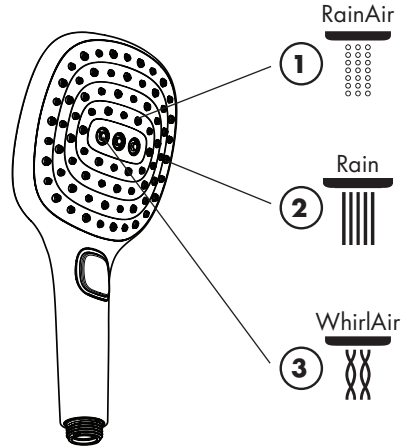
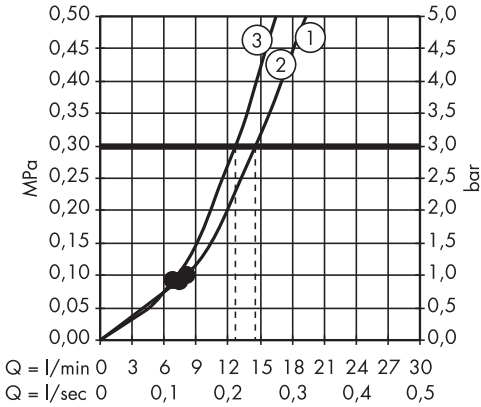
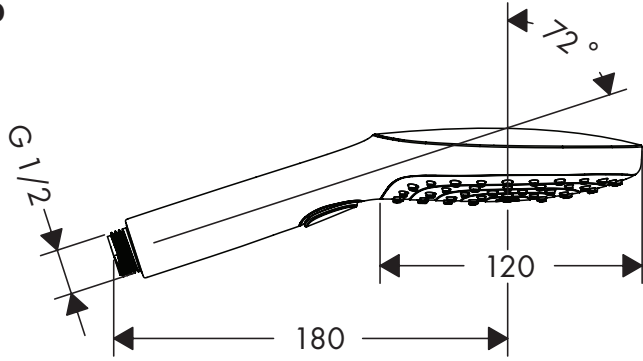

P-IX

DVGW

SVGW

ACS

WRAS

KIWA

NF

26520XXX

X

Raindance Select E 150

26550000 / 26550400

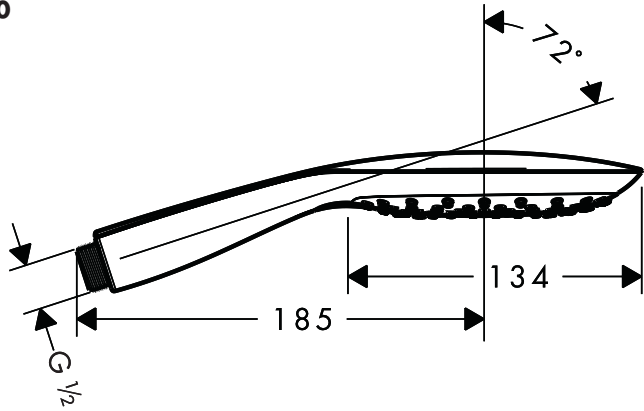

RainAir

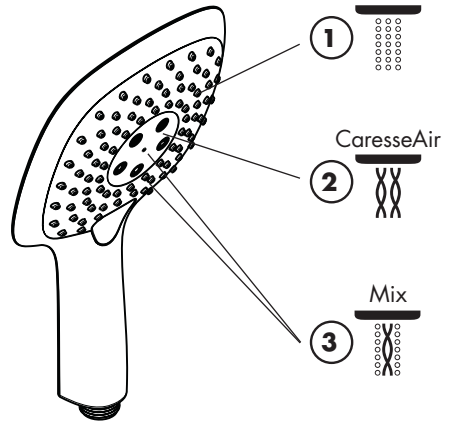
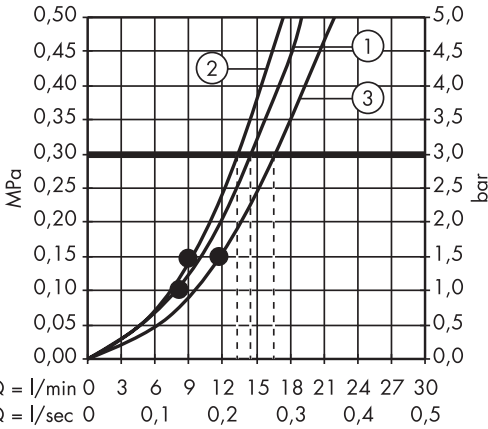

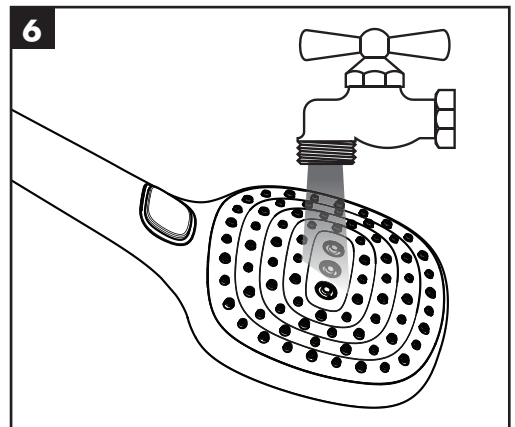
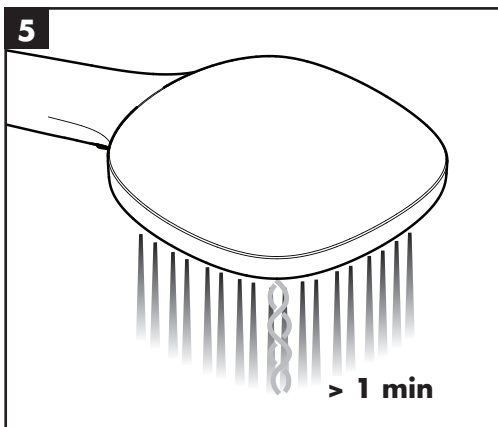
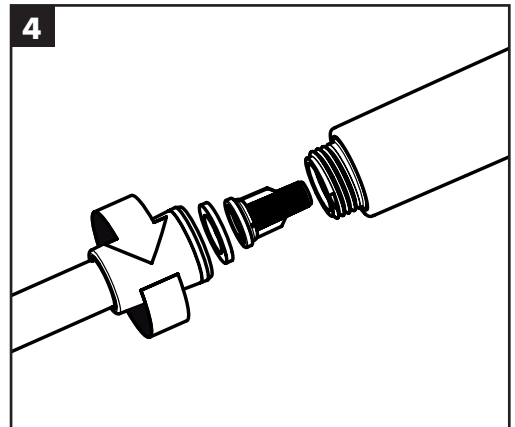
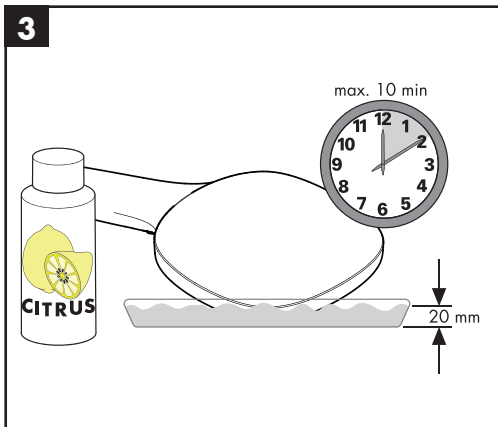
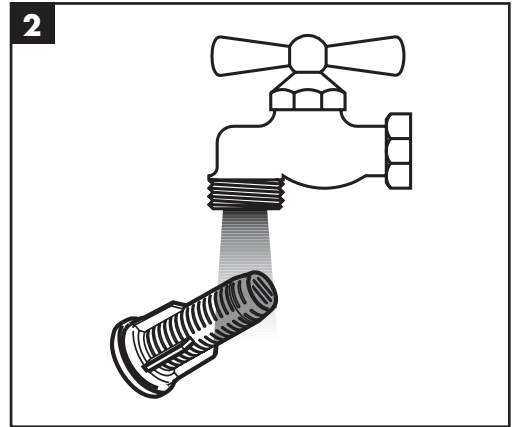
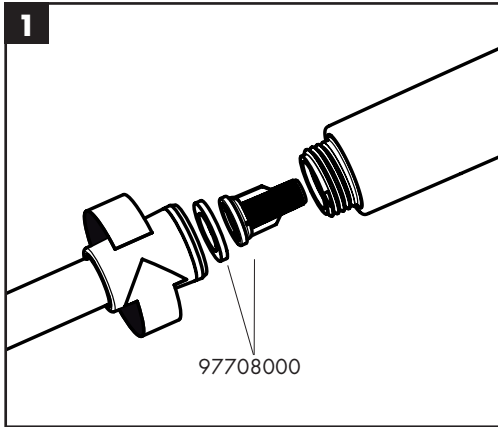

hansgrohe