

# Installation

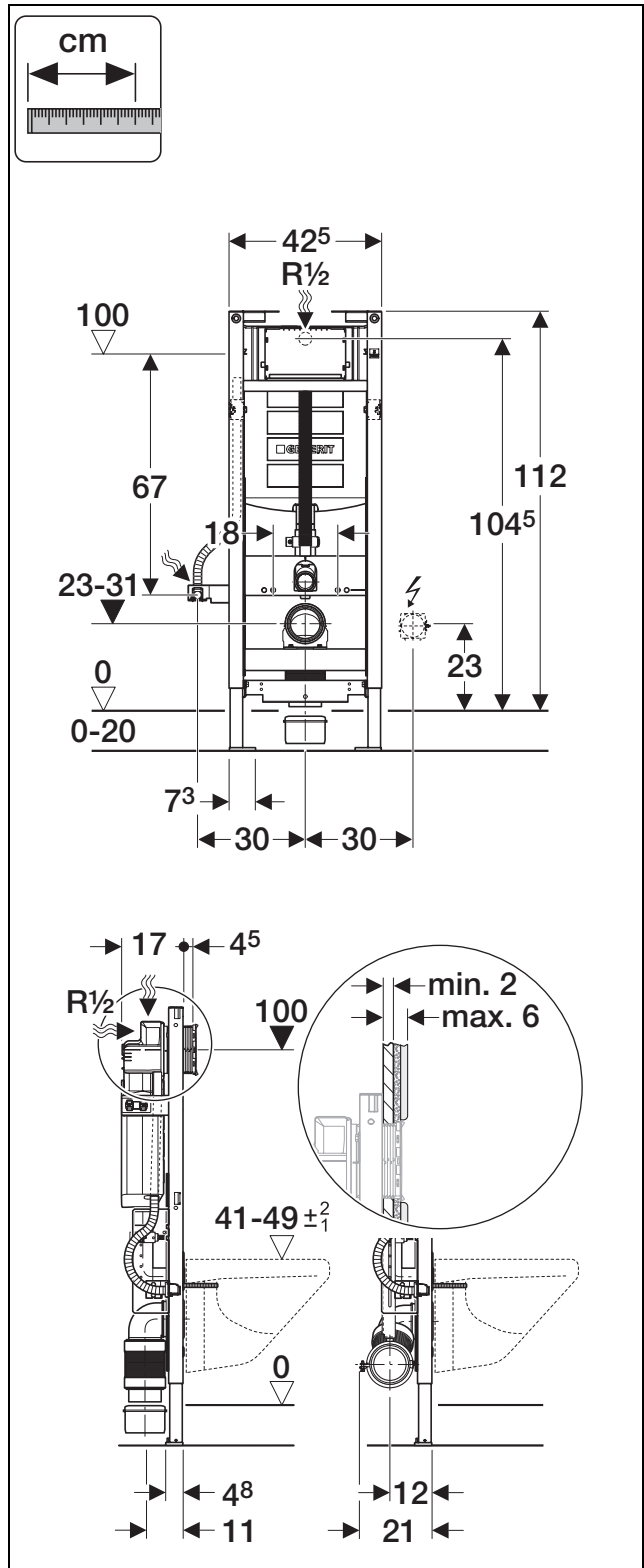

D24072-002&BDC © 02-2008

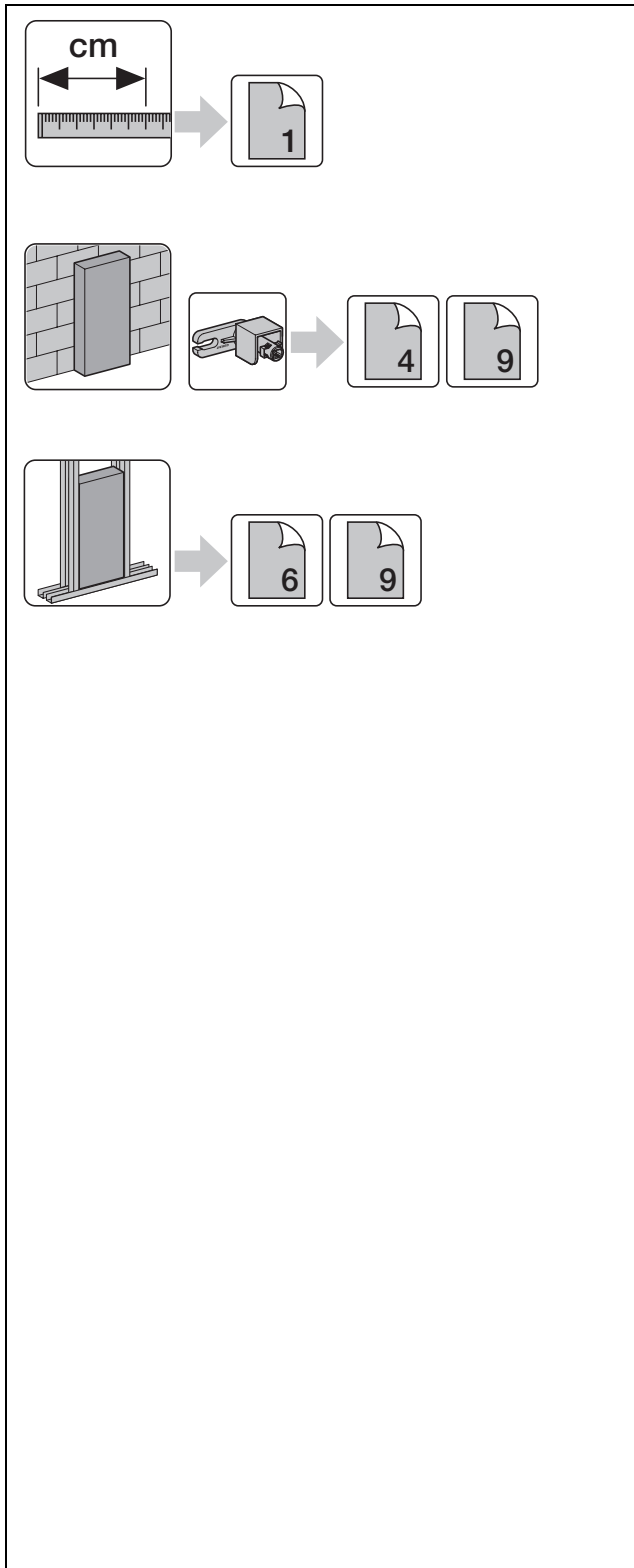
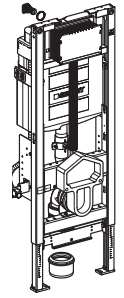